

Cellular and Mobile Communications

ECE – IV-I Sem

DEPT OF ELECTRONICS AND COMMUNICATION ENGINEERING

Prepared by:

K.Swapna

UNIT-I
INTRODUCTION TO CELLULAR MOBILE
RADIO SYSTEMS

Limitations of Conventional Mobile Systems

Inefficient Spectrum Utilization:

The spectrum utilization measurement is defined as the maximum number of subscribers that could be served per channel in the busy hour,

$$N = \frac{\text{Number of subscribers}}{\text{Number of channels}}$$

The typical values for N in conventional mobile systems is limited to 37 to 53. In this system, each channel can serve only one customer at a time in whole area. In this case, if 53 customers are associated per channel, then blocking probability is typically 50 percent during busy hour, which is very poor service performance. It is not efficient utilization of spectrum. To achieve this, each channel should be able to serve multiple subscribers simultaneously, so that larger number of customers can be accommodated in frequency-slot allotted for the service area. The major approaches for efficient utilization of RF spectrum are

- i. Single Side Band (SSB), Quadrature Amplitude Modulation (QAM) and similar other modulation techniques which require less bandwidth per user.
- ii. Code Division Multiple Access (CDMA) system in which many users can use same spectrum at the same time and the user is distinguished by a distinct code allotted to him.
- iii. Cellular system which re-uses the allocated spectrum in different geographical locations, which are located beyond radiation coverage of each other. This cellular concept solved a major problem faced by mobile telephone system world-wide, i.e. spectrum scarcity.

Poor Service Performance:

In conventional mobile systems, frequency reuse technique was not available, hence the number of customers allotted per channel was quite large (typically 37 to 53) which created a large blocking probability during busy hour. Large number of calls did not mature during the busy hour, deteriorating the service performance. This limited bandwidth allocation led to poor service performance.

Limited Service Capability:

In this system, there was no provision for hand-off, and hence when a mobile user moved from one geographical zone to other, his call was dropped and user had to initiate the call again. The limitation of service capability was overcome by handoff mechanism provided in cellular mobile telephone system.

Requirements of Mobile Communications

1. Terminal Mobility:

The portable subscriber set (small size and low weight) supported with small long-life power battery is required, so that users can carry the set anywhere he moves.

2. Wireless Connectivity :

The user's set and mobile telephone base station should have wireless connectivity for free mobility.

3. Personal Mobility :

The user should be able to use the same telephone number wherever he goes, whether in his home coverage area or outside coverage area with roaming facility.

4. Value addition :

Modern mobile communication is not restricted to voice only. It should be supported with facilities to exchange all sorts of information voice, data, image, video, multimedia for which it requires large bandwidth and interfacing with various types of devices like telephone set, laptop, digital note book, etc.

5. Fast and efficient call processing

Basic Cellular System

A Basic Cellular network has following components

1. Mobile Unit
2. Cell Site (Base Station)
3. MTSO (Mobile Telephone Switching Office)
4. System interconnects and
5. Communication protocol

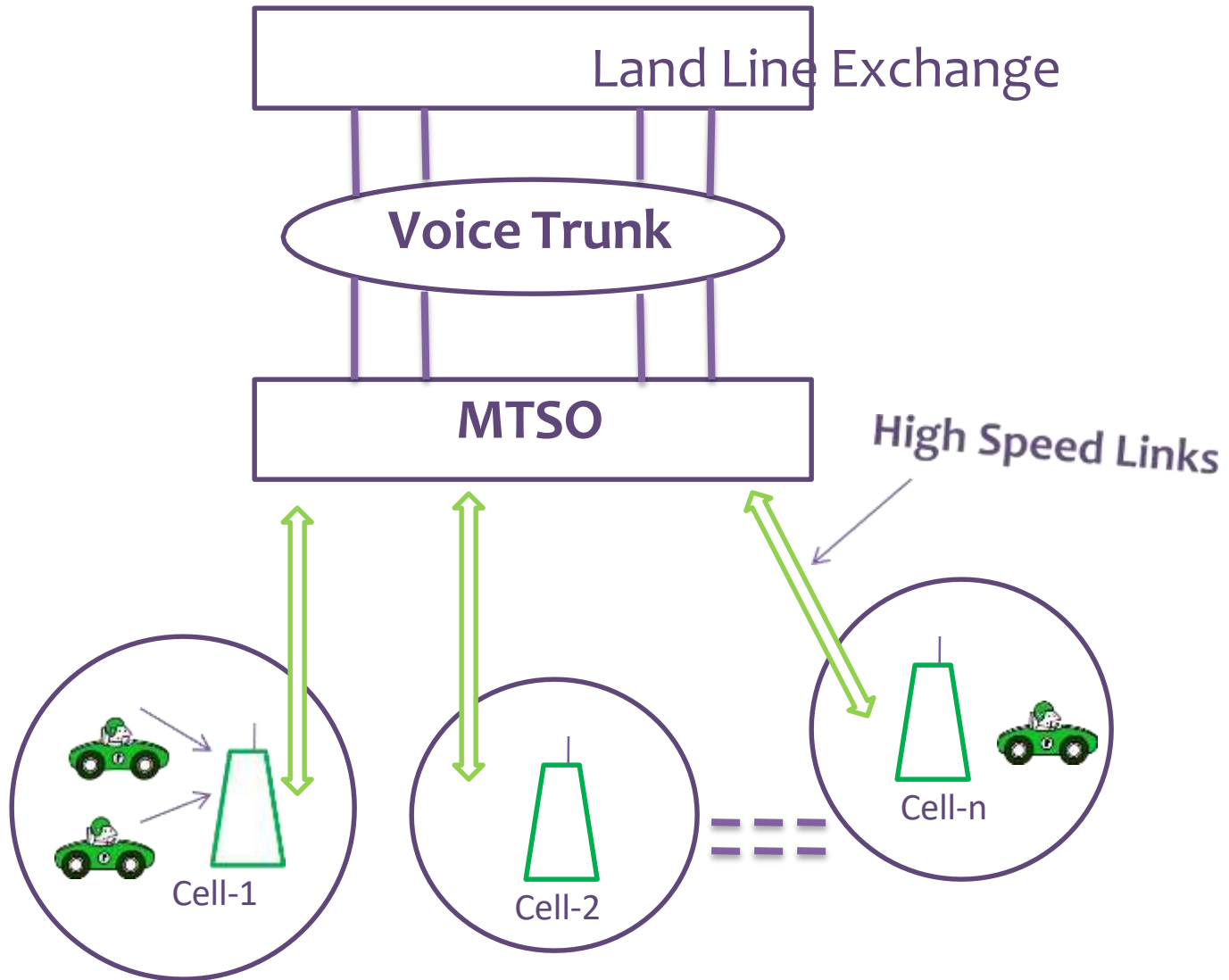

A Basic Cellular System

Mobile Unit:

A mobile unit is a portable, low weight handset carried by the user which has wireless connectivity with nearest base station. A simple mobile unit contains unit, a radio transceivers and an antenna system. The transceiver consists of a transmitter and receiver for two way telephonic conversation. It consists of a frequency synthesizer for timing the designated channels. The control unit houses all the user interfaces.

Cell Site:

It provides an interface between the mobile unit and the MTSO. It is also known as base station and consists of control unit (base station controller), radio cabinets, antennas, a power plant and data terminals. It is connected with MTSO on one side wideband media and on the other side has wireless connectivity with mobile unit.

MTSO(Mobile Telephone Switching Office)

It is the heart of the mobile system. Its processor provides cellular administration and central coordination. It may also be connected with landline telephone network. It contains the cellular processor and the cellular switch.

The cellular switch is an analog or digital telephone exchange which controls switching between landline subscriber unit to base station for landline to mobile connectivity and vice versa. It controls switching between a base station to another base station for mobile to mobile conversation. The cellular processor processes the data received from base station controllers regarding the status of mobile unit. It also processes the diagnostic data and billing information.

System Interconnect:

The radio connectivity, voice grade four wire-line connectivity, optical fiber connectivity, microwave link, data link, etc., can be used to connect mobile unit, base stations, MTSO and public switched telephone network (PSTN). Each mobile unit can use only one channel. But this channel is not fixed. It can be assigned to any channel from the entire band allocated for the service area. For second conversation, some other channel may be assigned. Microwave link or T-carriers(wire line) are used to carry both data and voice between MTSO and the base-station. The voice-trunks are used to connect MTSO with PSTN. For wideband data and information, optical fibers can be used.

Communication Protocols: The protocols govern the process of call connection and disconnection at the end of the conversation.

Example : IS-54, IS-95, GSM, etc.

Performance Criteria

Voice Quality :

Voice quality is a complicated parameter for design engineers. Because it depends person to person and also all mobile users do not use a common equipment, so in this area a designer cannot decide how to build a system without knowing the voice quality that will satisfy the users.

In Military, Air force communication, this is not a problem, because Armed forces must use the assigned equipment. But in general, the voice quality depends upon the following criterion, a set value 'x' at which 'y' percent of customers rate the system voice quality as good or excellent (from transmitter to receiver)

Generally following scale used for circuit merits (CM) in respect of voice quality.

Circuit Merits in respect of Voice Quality

Circuit Merit	Score	Quality Scale
CM 1	1	(Unsatisfactory) not understandable
CM 2	2	Poor (understandable, but repetitions are required)
CM 3	3	Fair (Occasional repetitions required)
CM 4	4	Good (understandable, but some noise)
CM 5	5	Excellent

Service Quality:

Following parameters are required to judge the service quality,

1. Coverage area
2. Grade of service
3. Number of dropped Calls

1) Coverage Area: If a system serve as far as possible i.e., large area, it is good. But it is not possible to serve 100 percent area due to irregulars Geographical structure and following reasons.

- i) The transmitted power must be very high to illuminate weak spots (where reception is not faithful), which increases the cost.
- ii) The higher the transmitted power, higher the interference.

Hence, a system usually cover 90% area in flat parts, while 60 to 75% in hill parts.

2) Grade of Services : The grade of service is very good, if number of block calls out of 100 is two or less than 2 in peak hour. However, the blocking probability at each cell site is different. To decrease the block calls or blocking probability requires a good system plan and sufficient number of radio channels as well as number of BTS.

3) Dropped Calls: To measure the dropped calls, there is a parameter named call drop rate. If during Q calls, Q-1 calls are completed, then call drop rate is $1/Q$, if Q-2 calls are completed then call drop rate is $2/Q$. As far as possible call drop must be low.

A system may need to provide some extra features like, voice mail service, Automatic roaming, call waiting, live news, rail reservation facilities and navigation services.

Operation of Cellular Systems

The Operation of a cellular system can be divided into four parts, besides a handoff procedure.

1. Mobile Unit Initialization:

Out of total radio channels (say 416) available for a cellular coverage area, few channels (say 21) are designated for setting up connections, and are called as set-up-channels. When a subscriber activates his mobile unit by switching on the power, its receiver scans the set-up channels, selects the strongest one (nearest cell-site) and locks on it for a certain time. This is known as self-location scheme. This scheme has the disadvantage that trace of idle mobile units does not appear on cell site. This limitation can be removed by a process called registration.

2. Mobile Unit Originated Call :

The mobile user enters the called number and presses the send button, his request goes to cell-site through a set-up channel. The cell-site, sends the request via a high speed link to MTSO for allocating a voice-channel. The MTSO allots a suitable free voice channel and cell-site links two subscribers for conversation.

3. Land Line Originated Call:

When a land-line subscriber dials a mobile unit number, the respective telephone exchange transfers it to MTSO via voice grade trunk lines. The MTSO sends this information on relevant cell sites along with a search algorithm. Each cell-site uses its setup channel to transmit information and mobile unit recognizes it and locks into it.

4. Call Termination : When the mobile user switches off its transmitter, a signaling tone is sent to the respective cell-site and both sides makes the voice channels free.

CONTENTS

- INTRODUCTION
- 1G TECHNOLOGY
- 2G TECHNOLOGY
- MODELS OF 1G & 2G
- 2.5 TECHNOLOGY
- 3G TECHNOLOGY
- 4G TECHNOLOGY
- WIRELESS APPLICATIONS
- WIRELESS SERVICES
- EVOLUTION FROM 1G TO 5G TECHNOLOGY

INTRODUCTION

WHAT IS WIRELESS ?

The word wireless in dictionary is defined "having no wires ” .

In networking terminology , wireless is the term used to describe any computer network where there is no physical wired connection between sender and receiver, but rather the network is connected by radio waves and or microwaves to maintain communications.

Wireless networking utilizes specific equipment such as NICs and Routers in place of wires (copper or optical fiber).

1G TECHNOLOGY

- ★ 1G refers to the first generation of wireless telephone technology, mobile telecommunications which was first introduced in 1980s and completed in early 1990s.
- ★ It's Speed was upto 2.4kbps.
- ★ It allows the voice calls in 1 country.
- ★ 1G network use Analog Signal.
- ★ AMPS was first launched in USA in 1G mobile systems.

DRAWBACKS OF 1G

- ★ Poor Voice Quality Poor Battery Life Large
- ★ Phone Size No Security Limited Capacity
- ★ Poor Handoff Reliability 1G Wireless System



2G TECHNOLOGY

❖ 2G technology refers to the 2nd generation which is based on GSM.

❖ It was launched in Finland in the year 1991.

❖ 2G network use digital signals.

❖ It's data speed was upto 64kbps.

Features Includes:

✓ It enables services such as text messages, picture messages and MMS (multi media message).

✓ It provides better quality and capacity .

based on



DRAWBACKS OF 2G

- ❑ 2G requires strong digital signals to help mobile phones. If there is no network coverage in any specific area, digital signals are not possible.
- ❑ These systems are unable to handle complex data such as Videos.



2G Wireless System

2.5G TECHNOLOGY

❖ 2.5G is a technology between the second (2G) and third (3G) generation of mobile telephony.

❖ 2.5G is sometimes described as 2G Cellular combined with General Packet Radio Service (GPRS).

Features Includes:

- ✓ Phone Calls
- ✓ Send/Receive E-mail Messages
- ✓ Web Browsing
- ✓ Speed : 64-144 kbps
- ✓ Camera Phones
- ✓ Take a time of 6-9 mins. to download a 3 mins. 1

Technology



3G TECHNOLOGY

- ◆ 3G technology refer to third generation which was introduced in year 2000s.
- ◆ Data Transmission speed increased from 144kbps-2Mbps.
- ◆ Typically called Smart Phones and features increased its bandwidth and data transfer rates to accommodate web-based applications and audio and video files.



FEATURES OF 3G TECHNOLOGY

- ✓ Providing Faster Communication
- ✓ Send/Receive Large Email Messages
- ✓ High Speed Web / More Security Video Conferencing
/ 3D Gaming
- ✓ TV Streaming/ Mobile TV/ Phone Calls
- ✓ Large Capacities and Broadband Capabilities
- ✓ 11 sec – 1.5 min. time to download a 3 min Mp3 song.

DRAWBACKS OF 3G TECHNOLOGY

- ◆ Expensive fees for 3G Licenses Services
- ◆ It was challenge to build the infrastructure for 3G
- ◆ High Bandwidth Requirement
- ◆ Expensive 3G Phones.
- ◆ Large Cell Phones

4G TECHNOLOGY

- ◆ High-speed data access
- ◆ High quality streaming video Combination of wi-fi and wi-max
- ◆ Capable of providing 100Mbps – 1Gbps speed.
- ◆ One of the basic term used to describe 4G is **MAGIC**.

MAGIC:

Mobile **M**ultimedia **A**nytime Anywhere **G**lobal

Mobility **S**upport

Integrated **W**ireless Solution **C**ustomized Personal **S**ervices

Also known as Mobile Broadband Everywh



4G (Anytime, Anywhere)

- The next generations of wireless technology that promises higher data rates and expanded multimedia services.
- Capable to provide speed 100Mbps-1Gbps.
- High QOS and High Security
- Provide any kind of service at any time as per user requirements, anywhere.

Features Include:

- More Security
- High Speed
- High Capacity
- Low Cost Per-bit etc.



Hexagonal Shaped Cells

The Hexagonal Shaped communication cells are artificial and that shape cannot be generated in the real world. Engineers draw hexagonal shaped cells on a layout to simplify the planning and design of cellular system because it approaches the circular shape, that is the ideal power coverage area. The circular shapes have overlapped areas which make the drawing unclear

Hexagonal cells

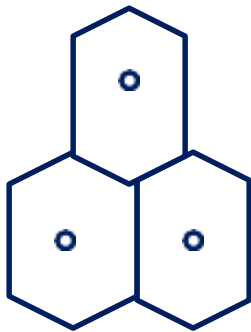

Fictitious

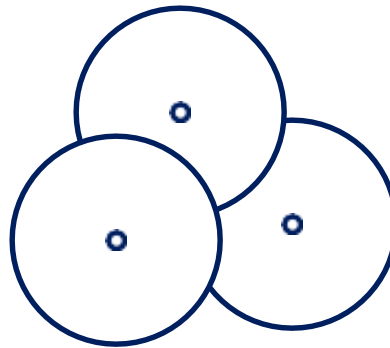

Ideal

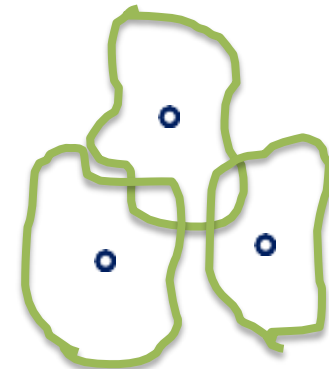

Real

Signal Coverage

Topics to be discussed

❖ Parameters of Mobile Multipath Channels

- Time dispersion parameters
- Coherence bandwidth
- Doppler spread and coherence time

❖ Types of Small-Scale Fading

Parameters of Mobile Multipath Channels

- ❖ In order to compare different multipath channels and to develop some general design guidelines for wireless systems we need parameters which quantify the multipath channel. The parameters are:
 - Delay spread
 - Coherence bandwidth
 - Doppler spread
 - Coherence time

Delay Spread

- ❖ The signal transmitted from a cell site and arriving at a mobile unit will be from different paths
- ❖ Each path has a different path length
- ❖ The time of arrival for each path is different.
- ❖ For an impulse transmitted at the cell site, by the time this impulse is received at the mobile unit it is no longer an impulse but rather a pulse with a spread width that we call the delay spread.

Delay Spread

- ❖ Mean excess delay
- ❖ RMS delay spread
- ❖ Excess delay spread

➤ Mean excess delay

Mean excess delay is the first moment of the power delay profile and is defined by the equation

$$\bar{\tau} = \frac{\sum_k a_k^2 \tau_k}{\sum_k a_k^2} = \frac{\sum_k P(\tau_k) \tau_k}{\sum_k P(\tau_k)}$$

➤ RMS delay spread

RMS delay spread is the square root of the second central moment of the power delay profile and is defined by the equation:

$$\sigma_{\tau} = \sqrt{\overline{\tau^2} - (\overline{\tau})^2}$$

where

$$\overline{\tau^2} = \frac{\sum_k a_k^2 \tau_k^2}{\sum_k a_k^2} = \frac{\sum P(\tau_k) \tau_k^2}{h}$$

Excess delay spread

Maximum excess delay is defined as the $\tau_x - \tau_0$, where τ_0 is the first arriving signal and τ_x is the maximum delay at which a multipath component is within X dB of the strongest arriving multipath signal

Coherence bandwidth

- ❖ Coherence bandwidth B_c is a statistical measure of the range of frequencies over which the channel can be considered flat i.e., a channel which passes all spectral components with approximately equal gain and linear phase.
- ❖ Coherence bandwidth is the range of frequencies over which two frequency components have a potential for amplitude correlation.

Doppler Spread and Coherence Time

- ❖ Doppler Spread B_d is a measure of the spectral broadening caused by the time rate of change of the mobile radio channel and is defined as the range of frequencies over which the received doppler spectrum is essentially non-zero.
- ❖ When a signal of frequency f_c is transmitted, the received signal spectrum, called the Doppler spectrum, will have components $f_c - f_d$ to $f_c + f_d$, where f_d is the Doppler shift.
- ❖ Coherence time T_c is the time domain dual of Doppler spread and is used to characterize the time varying nature of the frequency dispersiveness of the channel in the time domain.

Introduction to Cellular Systems

- Solves the problem of spectral congestion and user capacity.
- Offer very high capacity in a limited spectrum without major technological changes.
- Reuse of radio channel in different cells.
- Enable a fix number of channels to serve an arbitrarily large number of users by reusing the channel throughout the coverage region.

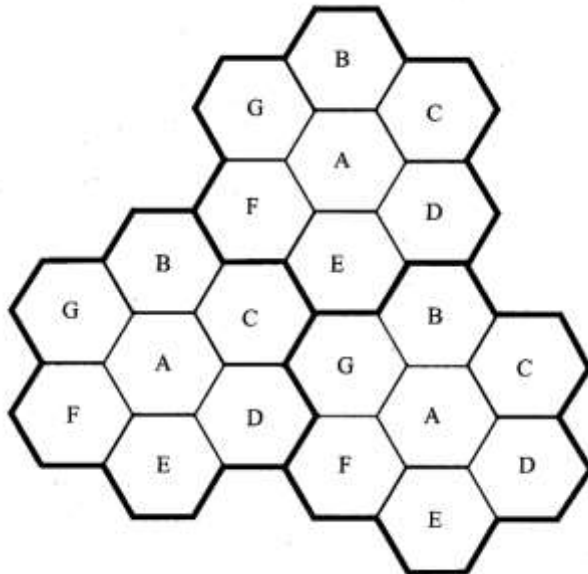

Frequency Reuse

- Each cellular base station is allocated a group of radio channels within a small geographic area called a *cell*.
- Neighboring cells are assigned different channel groups.
- By limiting the coverage area to within the boundary of the cell, the channel groups may be reused to cover different cells.
- Keep interference levels within tolerable limits.
- Frequency reuse or frequency planning

- seven groups of channel from A to G
- footprint of a cell - actual radio coverage
- omni-directional antenna v.s. directional antenna

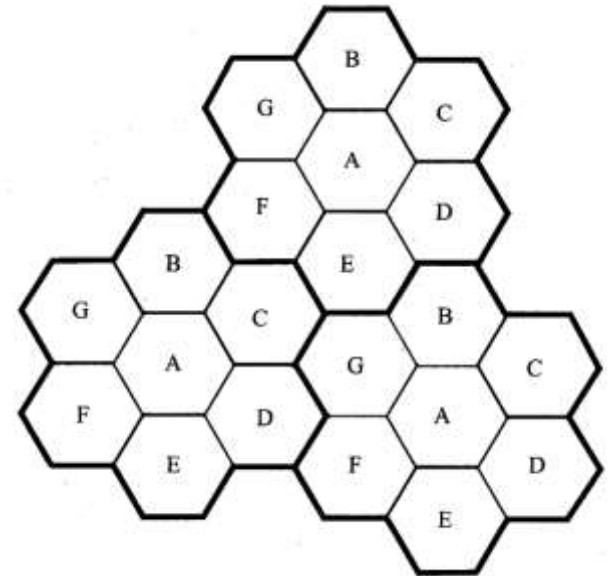

- Consider a cellular system which has a total of S duplex channels.
- Each cell is allocated a group of k channels, $k < S$.
- The S channels are divided among N cells.
- The total number of available radio channels

$$S = kN$$

- The N cells which use the complete set of channels is called *cluster*.
- The cluster can be repeated M times within the system. The total number of channels, C , is used as a measure of capacity

$$C = MkN = MS$$

- The capacity is directly proportional to the number of replication M .
- The cluster size, N , is typically equal to 4, 7, or 12.
- Small N is desirable to maximize capacity.
- The frequency reuse factor is given by $1/N$

- Hexagonal geometry has
 - exactly six equidistance neighbors
 - the lines joining the centers of any cell and each of its neighbors are separated by multiples of 60 degrees.
- Only certain cluster sizes and cell layout are possible.
- The number of cells per cluster, N , can only have values which satisfy

$$N = i^2 + ij + j^2$$

- Co-channel neighbors of a particular cell are $i-2$ and $i+2$

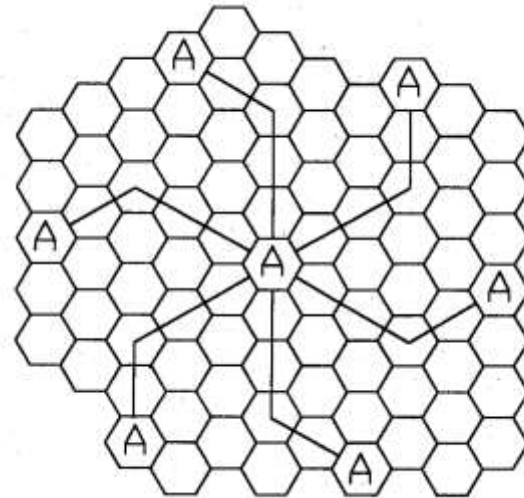

Co-channel Interference Reduction Factor

- $Q = D / R$
- $D = f(KI, C/I)$
- *where KI is the number of co channel interfering cells in the first tier and*
- *C/I is the received carrier-to-interference ratio at the desired mobile receiver*

Co-channel Interference Reduction Factor

- ❖ Reusing an identical frequency channel in different cells is limited by co-channel interference between cells, and the co-channel interference can become a major problem.
- ❖ Co-channel interference is a function of a parameter q defined as

$$q = D/R$$

- ❖ The parameter q is the co-channel interference reduction factor.
- ❖ The separation D in above equation is a function of K_1 and C/I .

$$D = f(K_1, C/I)$$

where K_1 is the number of co-channel interfering cells in the first tier and C/I is the received carrier-to-interference ratio at the desired mobile receiver. number of co-channel interfering cells in the first tier and C/I is the received carrier-to-interference ratio at the desired mobile receiver.

$$\frac{C}{I} = \frac{C}{\sum_{k=1}^{K_1} I_k}$$

❖ In a fully equipped hexagonal-shaped cellular system, there are always six co-channel interfering cells in the first tier as shown in Fig

below

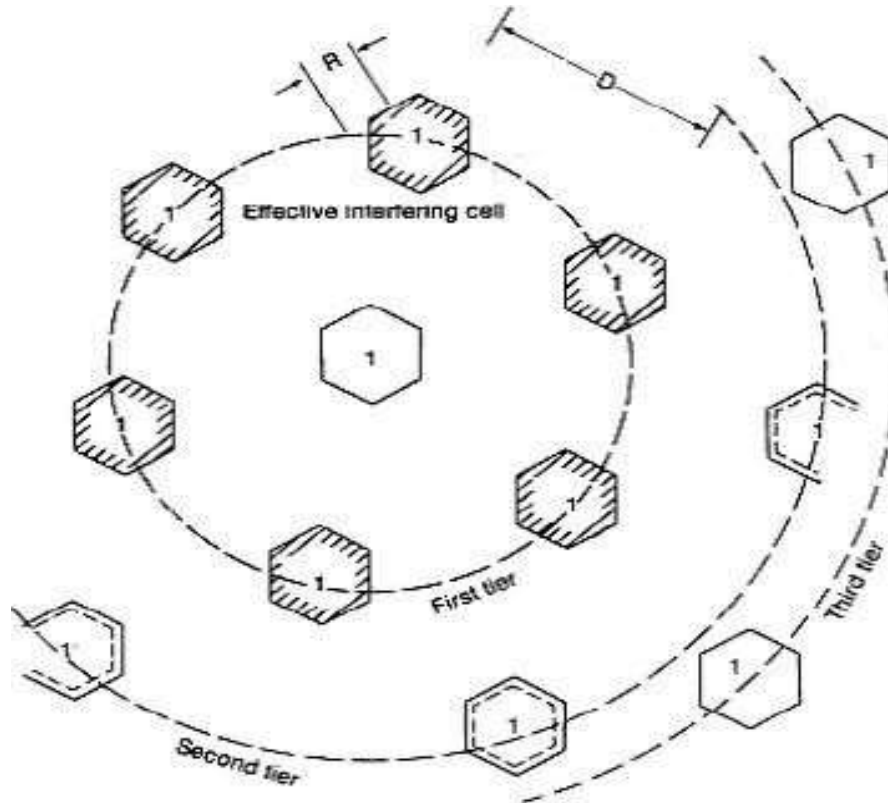

Fig: Six effective interfering cells of cell 1

- ❖ The maximum number of K_1 in the first tier can be shown as six.
- ❖ C/I can then be expressed as

$$\frac{C}{I} = \frac{R^{-\gamma}}{\sum_{k=1}^{K_1} D_k^{-\gamma}}$$

- ❖ The six co-channel interfering cells in the second tier cause weaker interference than those in the first tier. Therefore, the co-channel interference from the second tier of interfering cells is negligible.
- ❖ Thus C/I can be expressed as

$$\frac{C}{I} = \frac{1}{\sum_{k=1}^{K_1} \left(\frac{D_k}{R}\right)^{-\gamma}} = \frac{1}{\sum_{k=1}^{K_1} (q_k)^{-\gamma}}$$

Channel Assignment Strategies

- Frequency reuse scheme
 - increases capacity
 - minimize interference
- Channel assignment strategy
 - fixed channel assignment
 - dynamic channel assignment
- Fixed channel assignment
 - each cell is allocated a predetermined set of voice channel
 - any new call attempt can only be served by the unused channels
 - the call will be *blocked* if all channels in that cell are occupied
- Dynamic channel assignment
 - channels are not allocated to cells permanently.
 - allocate channels based on request.
 - reduce the likelihood of blocking, increase capacity.

Interference and System Capacity

- Sources of interference
 - another mobile in the same cell
 - a call in progress in the neighboring cell
 - other base stations operating in the same frequency band
 - noncellular system leaks energy into the cellular frequency band
- Two major cellular interference
 - co-channel interference
 - adjacent channel interference

Co-channel Interference and System Capacity

- Frequency reuse - there are several cells that use the same set of frequencies
 - co-channel cells
 - co-channel interference
- To reduce co-channel interference, co-channel cell must be separated by a minimum distance.
- When the size of the cell is approximately the same
 - co-channel interference is independent of the transmitted power
 - co-channel interference is a function of
 - R : Radius of the cell
 - D : distance to the center of the nearest co-channel cell
- Increasing the ratio $Q=D/R$, the interference is reduced.
- Q is called the co-channel reuse ratio

- For a hexagonal geometry

$$Q = \frac{D}{R} = \sqrt{3N}$$

- A small value of Q provides large capacity
- A large value of Q improves the transmission quality
- smaller level of co-channel interference
- A tradeoff must be made between these two objectives

Table 2.1 Co-channel Reuse Ratio for Some Values of N

	Cluster Size (M)	Co-channel Reuse Ratio(Q)
$i = 1, j = 1$	3	3
$i = 1, j = 2$	7	4.58
$i = 2, j = 2$	12	6
$i = 1, j = 3$	13	6.24

- Let i_0 be the number of co-channel interfering cells. The signal-to-interference ratio (SIR) for a mobile receiver can be expressed as

$$\frac{S}{I} = \frac{S}{\sum_{i=1}^{i_0} I_i}$$

S : the desired signal power

I_i : interference power caused by the i th interfering co-channel cell base station

- The average received power at a distance d from the transmitting antenna is approximated by

$$P_r = P_0 \left(\frac{d}{d_0} \right)^{-n}$$

or

$$P_r(\text{dBm}) = P_0(\text{dBm}) - 10n \log \left(\frac{d}{d_0} \right)$$

n is the path loss exponent which ranges between 2 and 4.

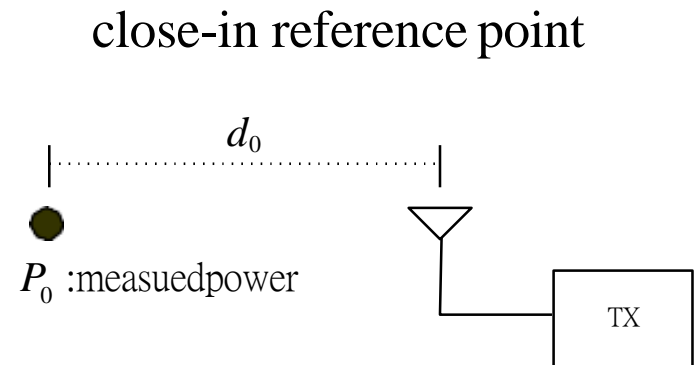

- When the transmission power of each base station is equal, SIR for a mobile can be approximated as

$$\frac{S}{I} = \frac{i R^{-n}}{\sum_{i=1}^{\infty} (D_i)^{-n}}$$

- Consider only the first layer of interfering cells

$$\frac{S}{I} = \frac{(D/R)^n}{i_0} = \frac{(\sqrt{3}N)^n}{i_0} \quad i_0 = 6$$

- Example: AMPS requires that SIR be greater than 18dB
 - N should be at least 6.49 for $n=4$.
 - Minimum cluster size is 7

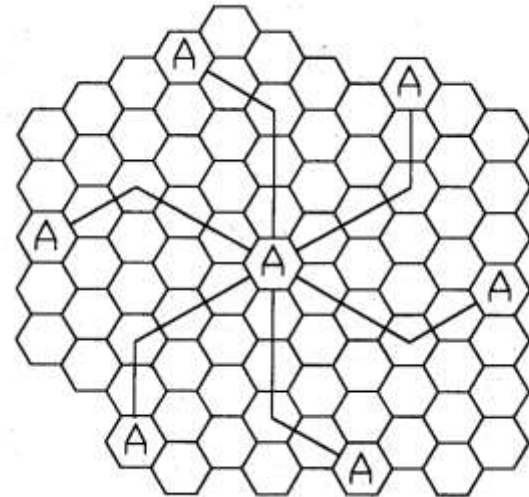

- For hexagonal geometry with 7-cell cluster, with the mobile unit being at the cell boundary, the signal-to-interference ratio for the worst case can be approximated as

$$\frac{S}{I} = \frac{R^{-4}}{2(D - R)^{-4} + (D - R/2)^{-4} + (D + R/2)^{-4} + (D + R)^{-4} + D^{-4}}$$

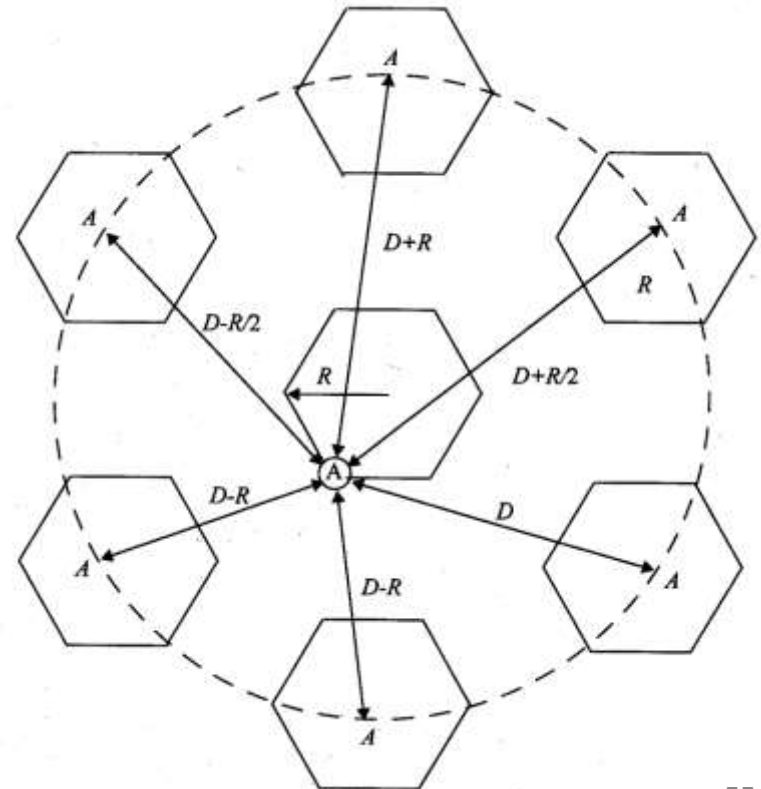

Adjacent Channel Interference

- Adjacent channel interference: interference from adjacent in frequency to the desired signal.
 - Imperfect receiver filters allow nearby frequencies to leak into the passband
 - Performance degrade seriously due to *near-far* effect.

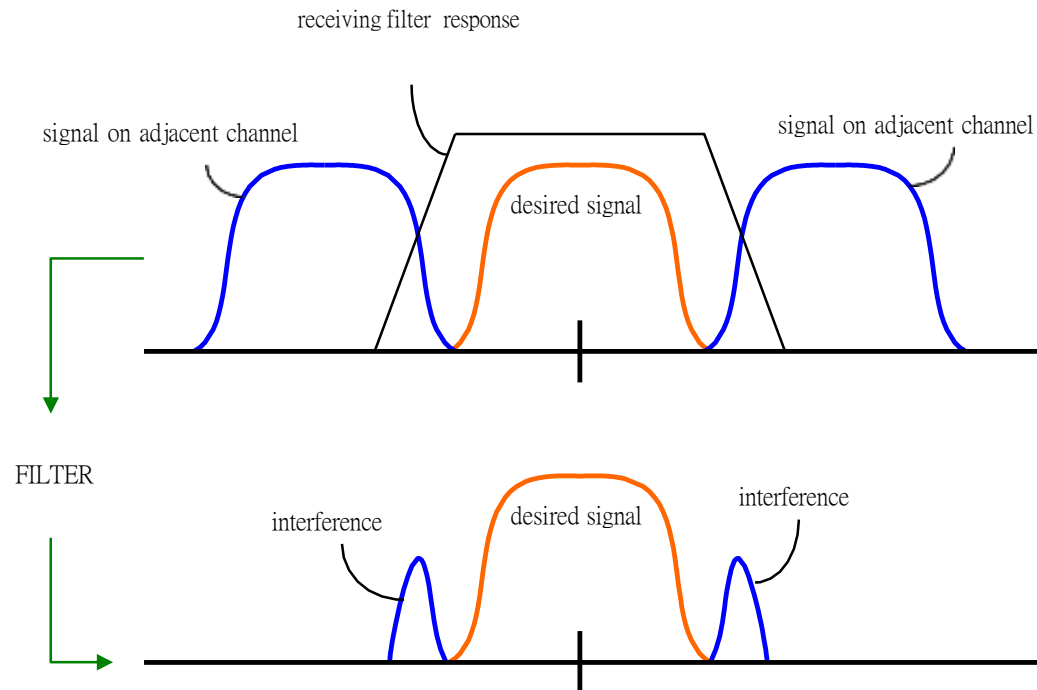

- Adjacent channel interference can be minimized through careful filtering and *channel assignment*.
- Keep the frequency separation between each channel in a given cell as large as possible
- A channel separation greater than six is needed to bring the adjacent channel interference to an acceptable level.

Trunking and Grade of Service

- Erlangs: One Erlangs represents the amount of traffic density carried by a channel that is completely occupied.
 - Ex: A radio channel that is occupied for 30 minutes during an hour carries 0.5 Erlangs of traffic.
- Grade of Service (GOS): The likelihood that a call is blocked.
- Each user generates a traffic intensity of A_u Erlangs given by

$$A_u = \mu H$$

H: average duration of a call.

μ : average number of call requests per unit time

- For a system containing U users and an unspecified number of channels, the total offered traffic intensity A , is given by

$$A = UA_u$$

- For C channel trunking system, the traffic intensity, A_c is given as

$$A_c = UA_u / C$$

Improving Capacity in Cellular Systems

- Methods for improving capacity in cellular systems
 - Cell Splitting: subdividing a congested cell into smaller cells.
 - Sectoring: directional antennas to control the interference and frequency reuse.
 - Coverage zone : Distributing the coverage of a cell and extends the cell boundary to hard-to-reach place.

Cell Splitting

- Split congested cell into smaller cells.
 - Preserve frequency reuse plan.
 - Reduce transmission power.

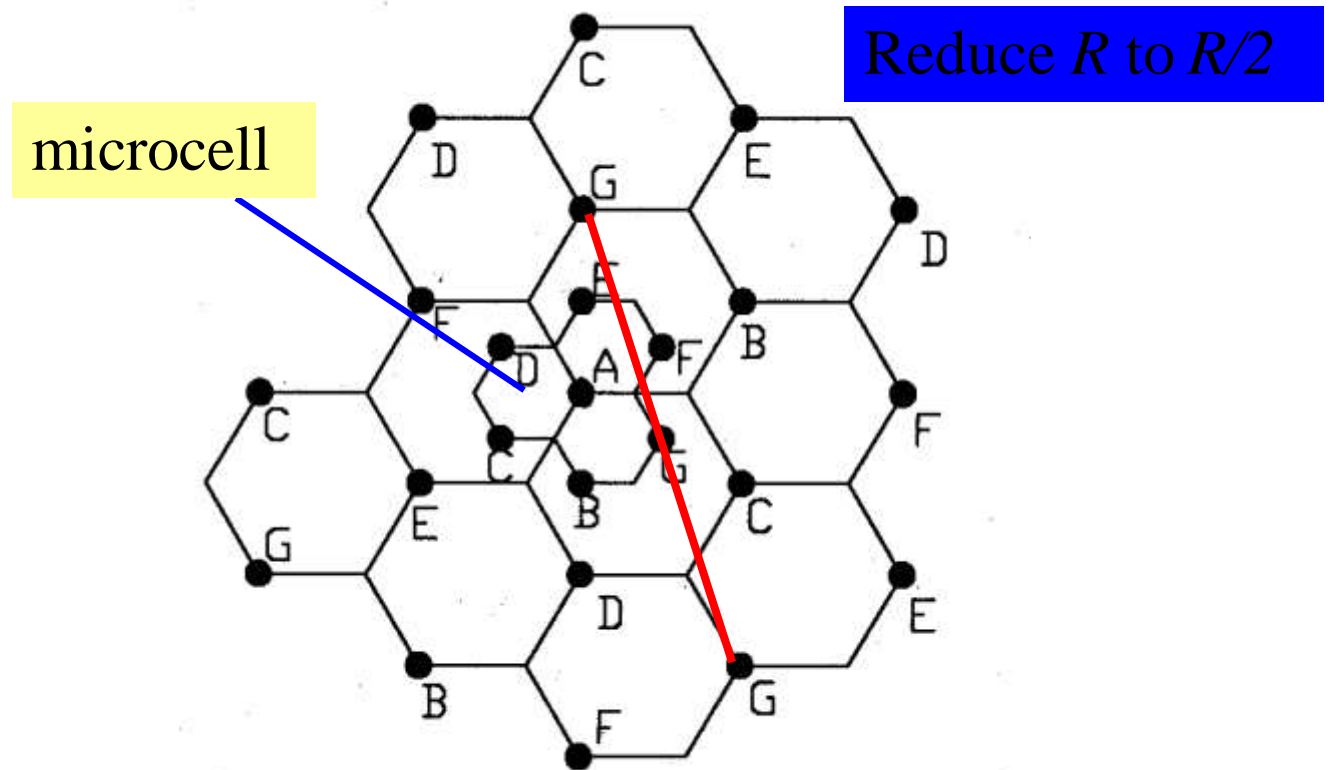
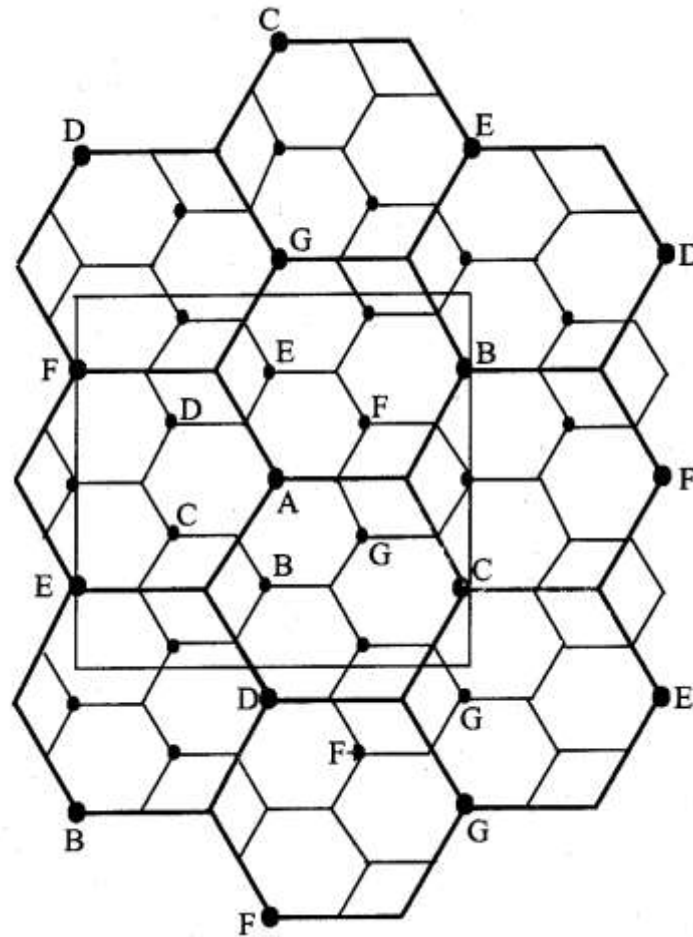

Illustration of cell splitting within a 3 km by 3 km square



- Transmission power reduction from P_{t1} to P_{t2}
Examining the receiving power at the new and old cell boundary

$$P_r [\text{at old cell boundary}] \propto P_{t1} R^{-n}$$

$$P_r [\text{at new cell boundary}] \propto P_{t2} (R / 2)^{-n}$$

- If we take $n = 4$ and set the received power equal to each other

$$P_{t2} = \frac{P_{t1}}{16}$$

- The transmit power must be reduced by 12 dB in order to fill in the original coverage area.
- Problem: if only part of the cells are split
 - Different cell sizes will exist simultaneously
- Handoff issues - high speed and low speed traffic can be simultaneously accommodated

Sectoring

- Decrease the *co-channel interference* and keep the cell radius R unchanged
 - Replacing single omni-directional antenna by several directional antennas
 - Radiating within a specified sector

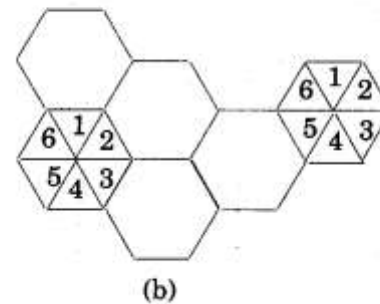
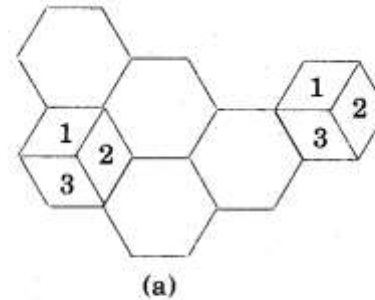

- Interference Reduction

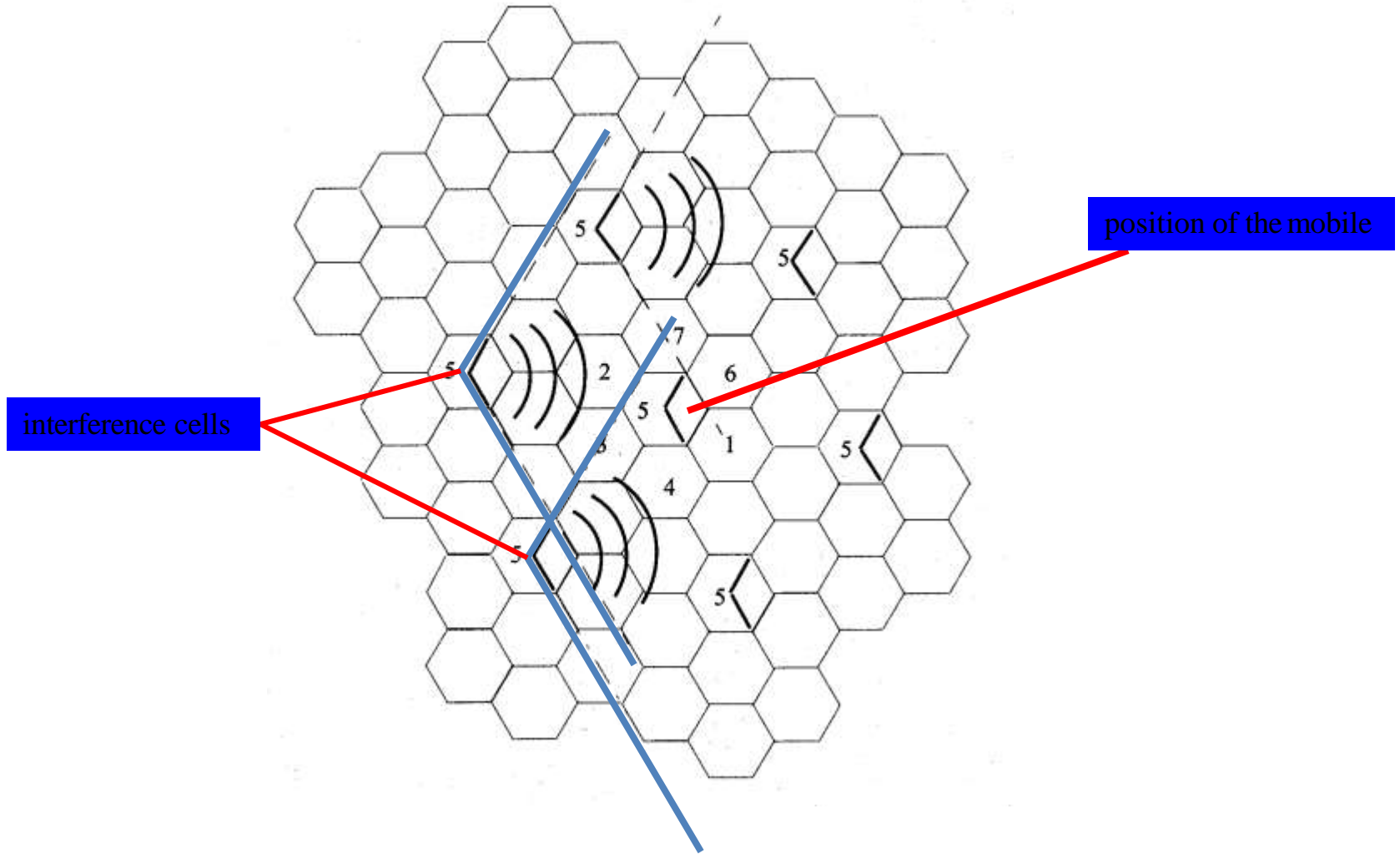

Advantages over sectoring

- As the mobile travels from one zone to another within the cell, it retains the same channel. Thus, a handoff is not required at the MSC
- A given channel is active only in the particular zone in which the mobile is traveling and hence the base station radiation is localized and interference is reduced
- The co-channel interference is also reduced as a large base station is replaced by several lower powered transmitters on the edges of the cell

Microcell Zone Concept

- Antennas are placed at the outer edges of the cell
- Any channel may be assigned to any zone by the base station
- Mobile is served by the zone with the strongest signal.
- Handoff within a cell
 - No channel re-assignment
 - Switch the channel to a different zone site
- Reduce interference
 - Low power transmitters are employed

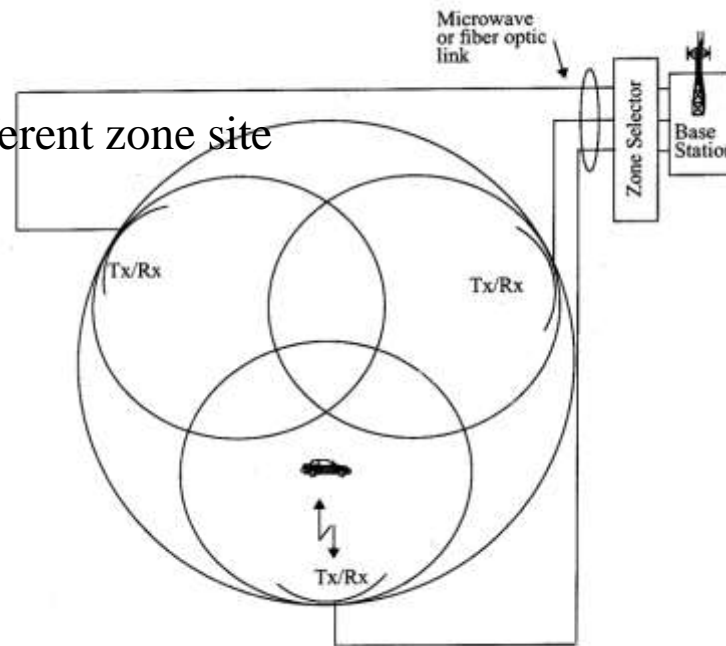

UNIT-II

CO-CHANNEL INTERFERENCE

Topics

- Introduction
- Real time co channel interference
- Co-channel measurement design of antenna system
- Antenna parameters and their effects
- Diversity receiver in co channel interference – different types

Co-Channel Interference

- Frequency reuse - there are several cells that use the same set of frequencies
 - co-channel cells
 - co-channel interference
- To reduce co-channel interference, co-channel cell must be separated by a minimum distance.
- When the size of the cell is approximately the same
 - co-channel interference is independent of the transmitted power
 - co-channel interference is a function of
 - R : Radius of the cell
 - D : distance to the center of the nearest co-channel cell
- Increasing the ratio $Q=D/R$, the interference is reduced.
- Q (co-channel interference reduction method) is called the co-channel reuse ratio

Co-channel Interference Reduction Factor

- $Q = D/R$
- $D = f(KI, C/I)$
- where *KI* is the number of co channel interfering cells in the first tier and
- *C/I* is the received carrier-to-interference ratio at the desired mobile receiver

Real time Co-Channel Interference

- Signal is $e_1 = S(t) \sin(\omega t + \phi_1)$
- Interference is
- The received signal is $e_2 = I(t) \sin(\omega t + \phi_2)$

- Where

$$e(t) = e_1(t) + e_2(t) = R \sin(\omega t + \psi)$$

- And

$$R = \sqrt{[S(t) \cos \phi_1 + I(t) \cos \phi_2]^2 + [S(t) \sin \phi_1 + I(t) \sin \phi_2]^2}$$

$$\psi = \tan^{-1} \frac{S(t) \sin \phi_1 + I(t) \sin \phi_2}{S(t) \cos \phi_1 + I(t) \cos \phi_2}$$

$$R^2 = [S^2(t) + I^2(t) + 2S(t)I(t) \cos(\phi_1 - \phi_2)]$$

$$X = S^2(t) + I^2(t)$$

$$Y = 2S(t)I(t) \cos(\phi_1 - \phi_2)$$

- The average processes on X and Y are

$$\overline{X} = \overline{S^2(t)} + \overline{I^2(t)}$$

$$\overline{Y^2} = 4\overline{S^2(t)I^2(t)}^{(1/2)} = 2\overline{S^2(t)I^2(t)}$$

- The signal-to-interference ratio

$$\Gamma = \frac{\overline{S^2(t)}}{\overline{I^2(t)}} = k + \sqrt{k^2 - 1}$$

$$k = \frac{\overline{X^2}}{\overline{Y^2}} - 1$$

- The sampling delay time should be small enough to satisfy

$$S(t) \approx S(t + \Delta t), \quad I(t) \approx I(t + \Delta t)$$

- Determining the delay time to meet the requirement of above equation for this calculation is difficult and is a drawback to this measurement technique.
- Therefore, real-time co-channel interference measurement is difficult to achieve in practice.

Co-channel measurement design of antenna system

Design of an Omni-directional Antenna System in the Worst Case

- The worst case is at the location where the mobile unit would receive the weakest signal from its own cell site but strong interferences from all interfering cell sites.
- To prove that a $K = 7$ cell pattern does not provide a sufficient frequency-reuse distance

Co-channel interference (a worst case)

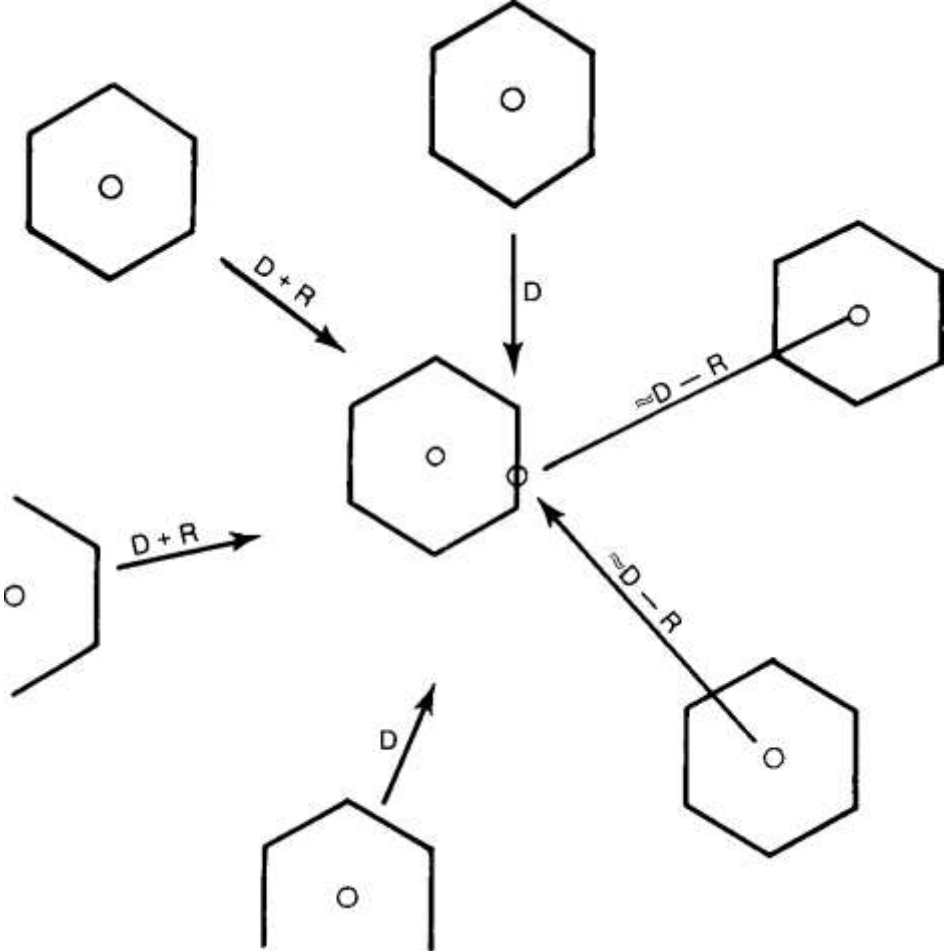

$$C \propto R^{-4} \quad I \propto D^{-4}$$

$$\begin{aligned} \frac{C}{I} &= \frac{R^{-4}}{2(D - R)^{-4} + 2(D)^{-4} + 2(D + R)^{-4}} \\ &= \frac{1}{2(q - 1)^{-4} + 2(q)^{-4} + 2(q + 1)^{-4}} \end{aligned}$$

where $q = 4.6$, $C/I = 17$ dB, which is lower than 18 dB.

If we use the shortest distance $D - R$, then

$$\frac{C}{I} = \frac{R^{-4}}{6(D - R)^{-4}} = \frac{1}{6(q - 1)^{-4}} = 28 = 14.47 \text{ dB}$$

Therefore, in an Omni-directional-cell system, $K = 9$ or $K = 12$ would be a correct choice. Then the values of q are

$$q = \begin{cases} \frac{D}{R} = \sqrt{3K} \\ 5.2 & K = 9 \\ 6 & K = 12 \end{cases}$$

$$\frac{C}{I} = 84.5 (=) 19.25 \text{ dB} \quad K = 9$$

$$\frac{C}{I} = 179.33 (=) 22.54 \text{ dB} \quad K = 12$$

Design of a Directional Antenna System

- Call traffic begins to increase
- Use the frequency spectrum efficiently
- Avoid increasing the number of cells
- *When K increases, the number of frequency channels assigned in a cell must become smaller*
- The efficiency of applying the frequency-reuse scheme decreases
- Instead of increasing k , we use directional antennas to reduce co channel interference

Three sector case

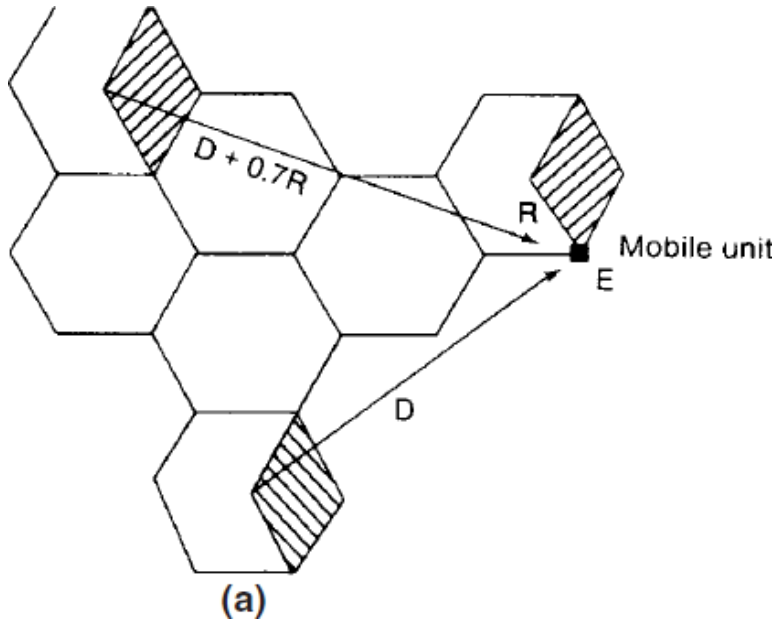

$$\begin{aligned} \frac{C}{I}(\text{worst case}) &= \frac{R^{-4}}{(D + 0.7R)^{-4} + D^{-4}} \\ &= \frac{1}{(q + 0.7)^{-4} + q^{-4}} \end{aligned}$$

Let $q = 4.6$; then

$$\frac{C}{I}(\text{worst case}) = 285 (=) 24.5 \text{ dB}$$

Six sector case

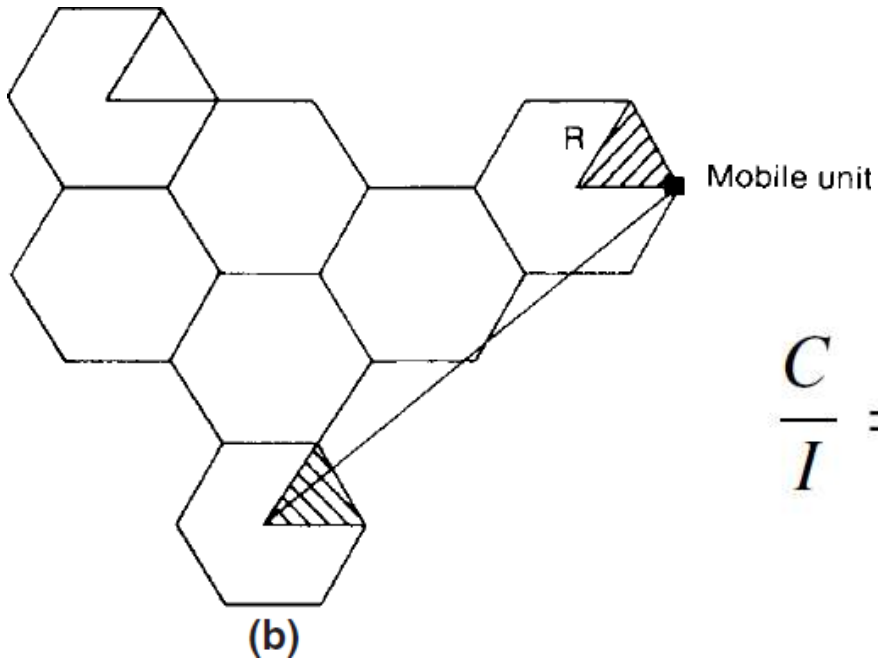

$$\frac{C}{I} = \frac{R^{-4}}{(D + 0.7R)^{-4}} = (q + 0.7)^4$$

For $q = 4.6$, the equation becomes

$$\frac{C}{I} = 794 (=) 29 \text{ dB}$$

Diversity Receiver In Co-Channel Interference –Different Types

- **Diversity:** It is the technique used to compensate for fading channel impairments. It is implemented by using two or more receiving antennas.
- Diversity is usually employed to reduce the depth and duration of the fades experienced by a receiver in a flat fading channel.
- These techniques can be employed at both base station and mobile receivers.

- Diversity requires no training overhead as a transmitter doesn't require one.
- It provides significant link improvement with little added cost.
- It exploits random nature of wave propagation by finding independent (uncorrelated) signal paths for communication
- It is a very simple concept where in one path undergoes a deep fade and another independent path may have a strong signal.
- As there is more than one path to select from, both the instantaneous and average SNRs at the receiver may be improved, often as much as 20-30 dB

Polarization Diversity

Principle :

Polarization diversity relies on the decor relation of the two receive ports to achieve diversity gain.

The two receiver ports must remain cross-polarized.

Space Diversity

Principle :

A method of transmission or reception, or both, in which the effects of fading are minimized by the simultaneous use of two or more physically separated antennas, ideally separated by one half or more wavelengths.

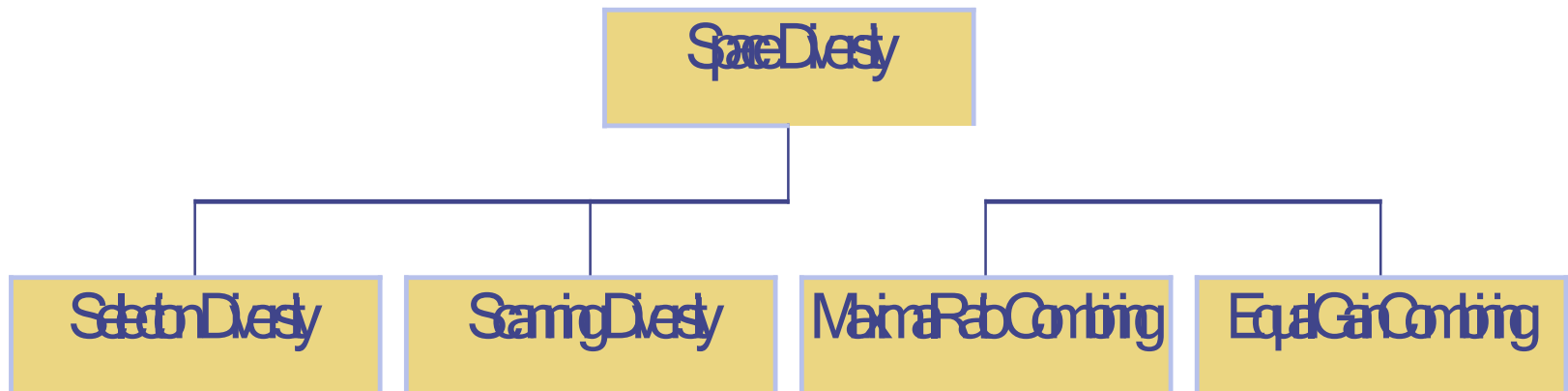

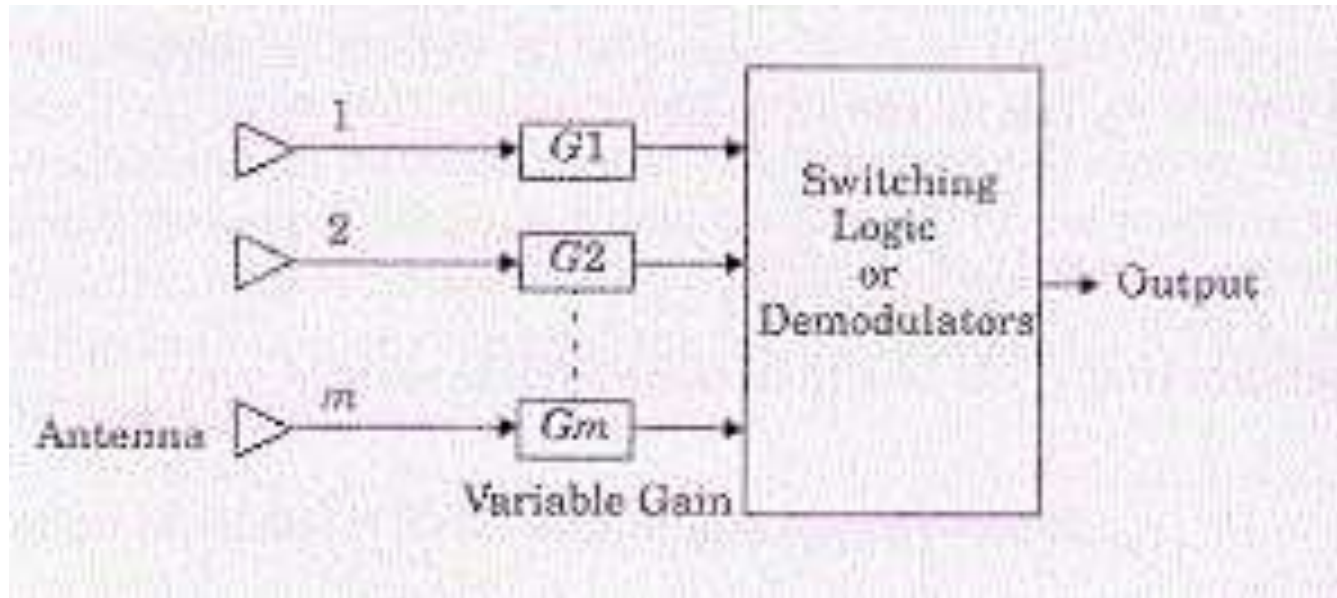

Signals received from spatially separated antennas on the mobile would have essentially uncorrelated envelopes for antenna separations of one half wavelength or more.

Frequency Diversity

Principle :

The same information signal is transmitted and received simultaneously on two or more independent fading carrier frequencies.

Time Diversity

Principle :

The signals representing the same information are sent over the same channel at different times.

- Time Diversity repeatedly transmits information at time spacing that exceeds the coherence time of the channel.
- Multiple repetitions of the signal will be received with multiple fading conditions, thereby providing for diversity.
- A modern implementation of time diversity involves the use of RAKE receiver for spread spectrum CDMA, where multipath channel provides redundancy in the transmitted message.

Adjacent-channel Interference

- next-channel (the channel next to the operating channel) interference
- neighboring-channel (more than one channel away from the operating channel) interference.

Next-Channel Interference

- next-channel interference will arrive at the mobile unit from other cell sites if the system is not designed properly.
- mobile unit initiating a call on a control channel in a cell may cause interference with the next control channel at another cell site.
- The filter with a sharp falloff slope can help to reduce all the adjacent-channel interference, including the next-channel interference.

Neighboring-channel Interference

- The channels which are several channels away from the next channel will cause interference with the desired signal.
- a fixed set of serving channels is assigned to each cell site.
- If all the channels are simultaneously transmitted at one cell-site antenna, a sufficient amount of band isolation between channels is required for a multichannel combiner to reduce inter modulation products.

Near-End-Far-End Interference

- *In One Cell*
- *In Cells of Two Systems*

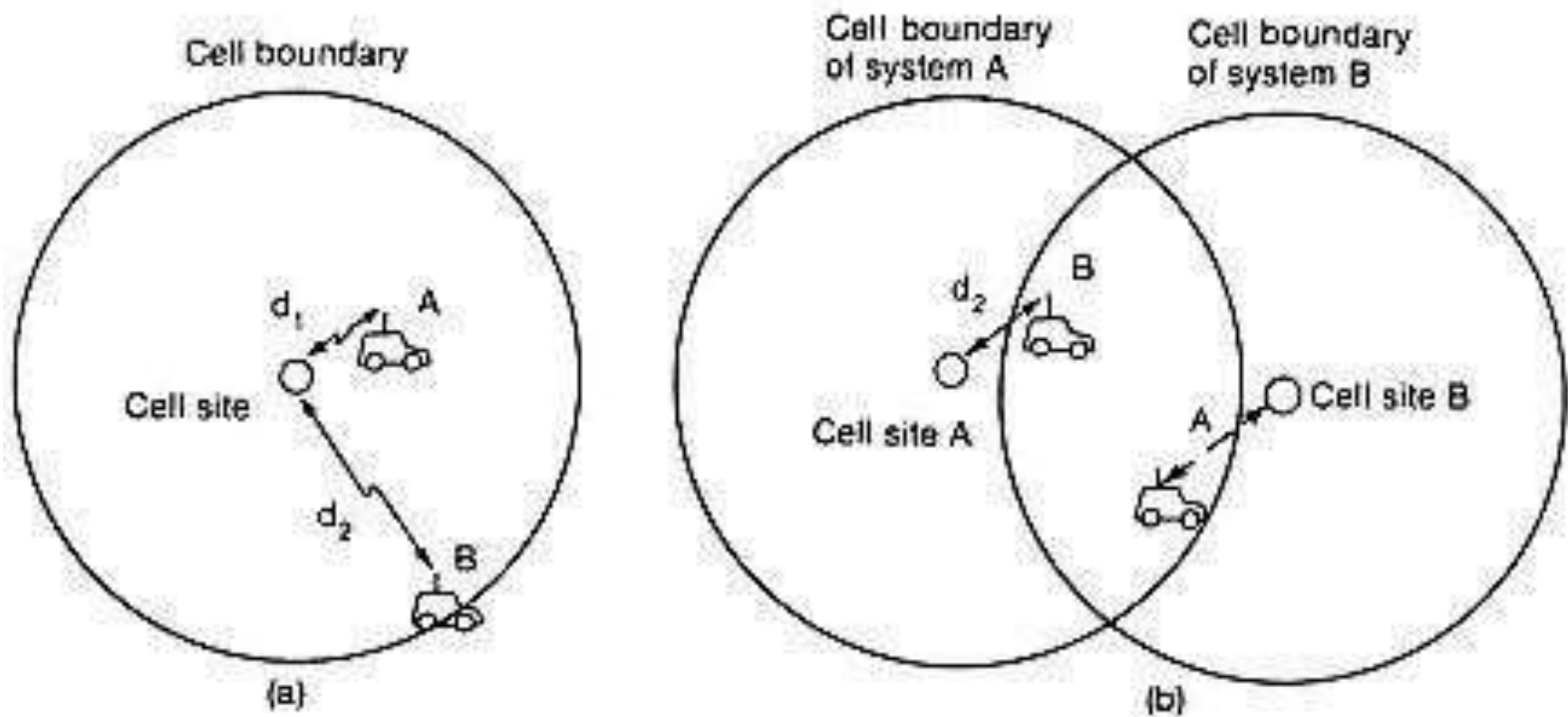

Near-End-Far-End Interference

In One Cell

The close-in mobile unit has a strong signal which causes adjacent-channel interference. In this situation, near-end-far-end interference can occur only at the reception point in the cell site.

Near-End-Far-End Interference

In Cells of Two Systems

- The frequency channels of both cells of the two systems must be coordinated in the neighborhood of the two-system frequency bands.

Avoidance of Near-End-Far-End Interference

- The near-end mobile units are the mobile units which are located very close to the cell site.
- These mobile units transmit with the same power as the mobile units which are far away from the cell site.

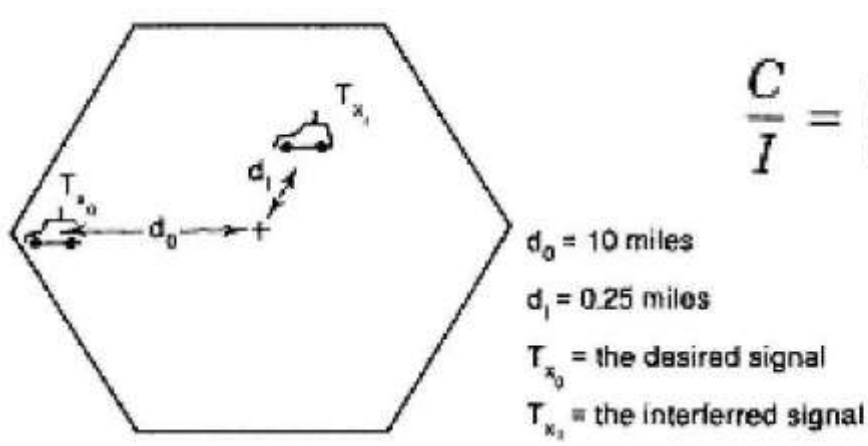

$$\frac{C}{I} = \left(\frac{d_0}{d_1} \right)^{-\gamma} \quad (7.4-1)$$

- d_0 - The distance between a calling mobile transmitter and a base-station receiver
- d_1 - The distance between a mobile transmitter causing interference and the same base-station receiver.
- The ratio d_1/d_0 is the near-end-far-end ratio.
- The effect of the near-end-far-end ratio on the carrier adjacent-channel interference ratio is dependent on the relative positions of the moving mobile units.

Interference between Systems

- *In One City*
- *In Adjacent Cities*

Interference between Systems In One City

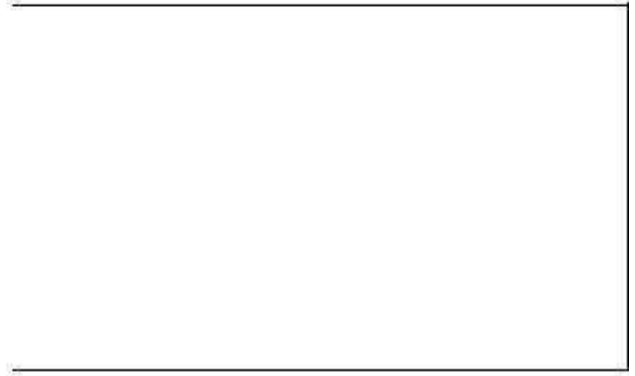
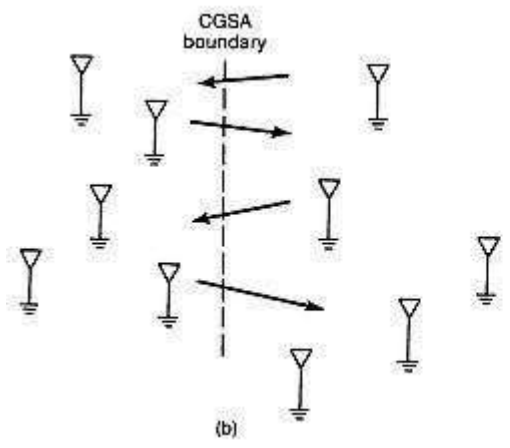
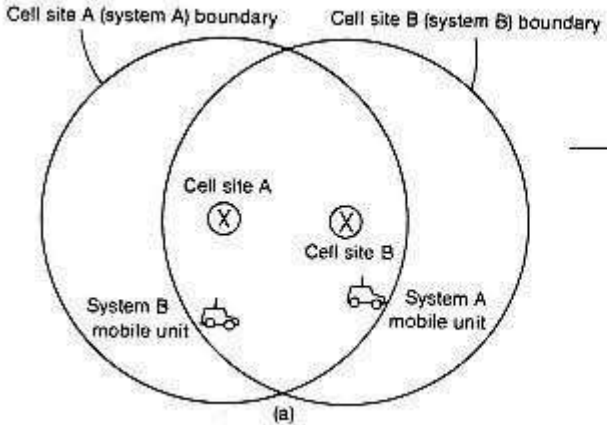

Interference between Systems

In Adjacent Cities

- Two systems operating at the same frequency band and in two adjacent cities or areas may interfere with each other if they do not coordinate their frequency channel use.
- Most cases of interference are due to cell sites at high altitudes
- In any start-up system, a high-altitude cell site is always attractive to the designer.
- Such a system can cover a larger area, and, in turn, fewer cell sites are needed.
- However, if the neighboring city also uses the same system block, then the result is strong interference, which can be avoided by the following methods.

- 1. **The operating frequencies** should be coordinated between two cities.
- The frequencies used in one city should not be used in the adjacent city.
- This arrangement is useful only for two low-capacity systems.
- 2. If both systems are high capacity, then **decreasing the antenna heights**

will result in reduction of the interference not only within each system but also between the two systems.

- 3. **Directional antennas** may be used.
- For example, if one system is high capacity and the other is low capacity, the low-capacity system can use directional antennas but still retain the high tower.
- In this situation frequency coordination between the two systems has to be worked out at the common boundary because all the allocated frequencies must be used by the high-capacity system in its service area but only some frequencies are used by the low-capacity system.

UHF TV Interference

- Two types of interference can occur between UHF television and 850-MHz cellular mobile phones.
- *Interference to UHF TV Receivers from Cellular Mobile Transmitters*
- *Interference of Cellular Mobile Receivers by UHF TV Transmitters*

- Interference between TV and cellular mobile channels is illustrated in Figure

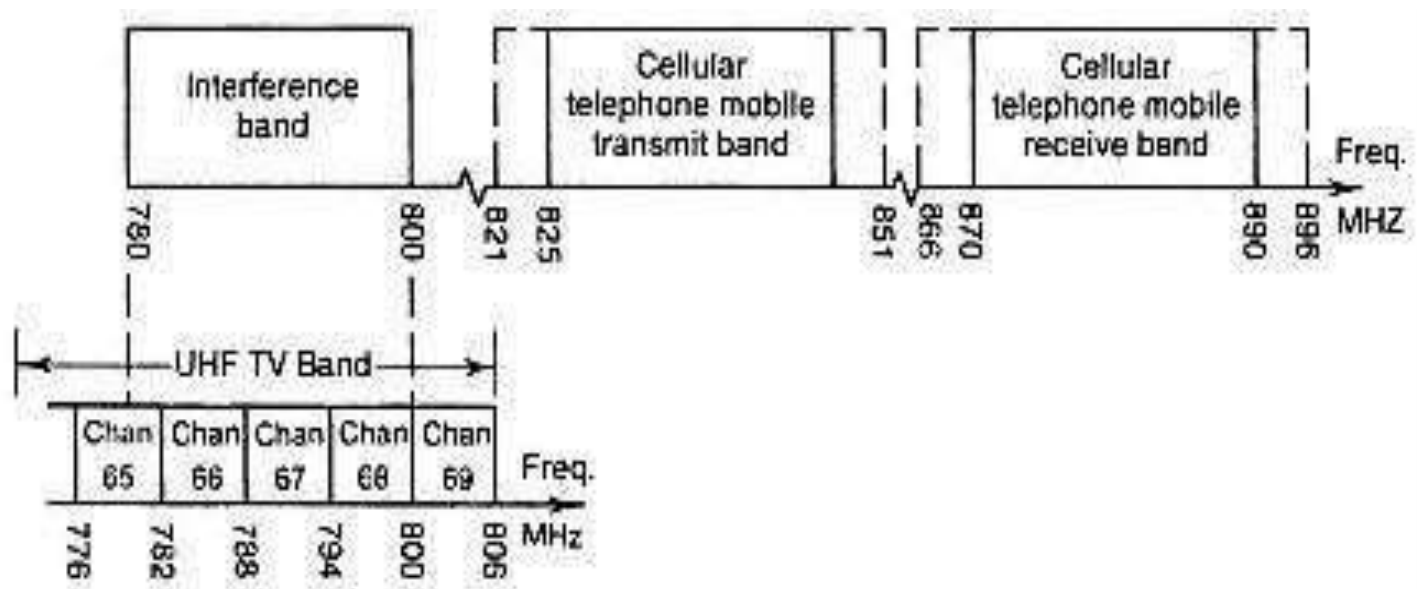

- Some UHF TV channels overlap cellular mobile channels.
- These two types of service can interfere with each other only under the following conditions.

1. ***Band region with overlapping frequencies.***

- Two services have been authorized to operate within the same frequency band region.

2. ***Image interference region.***

The TV receiver or the cellular receiver (mobile unit or cell site) can receive two transmitted signals, for instance, one from a TV channel and one from a cellular system, and produce a third-order inter modulation product which falls within the TV or the mobile receive band.

- Let f_{Tm} = mobile transmit frequency

 - = f_{Rc} = cell-site receive frequency

 - = f_{Tc} 45 MHz

- f_{Rm} = mobile receive frequency

 - = $f_{Tm} + 45$ MHz

 - = f_{Tc} = cell-site transmit frequency

 - $f_{T,TV}$ = TV transmit frequency

 - $f_{R,TV}$ = TV receive frequency

Third-order inter modulation gives the following results in two cases of interfering UHF TV receivers.

- *Case 1. When the mobile transmitter is located near a TV receiver*

Let

$$2f_{Tm} - f_{T,TV} = f_{Rm} \quad (7.9-1)$$

$$f_{Tm} = f_{Rm} - 45 \quad (7.9-2)$$

then

$$f_{Tm} = f_{T,TV} + 45 \quad (7.9-3)$$

- mobile transmit frequency f_{Tm} lies in the 825- to 845-MHz band
- TV transmit frequency $f_{T,TV}$ lies in the 780- to 800-MHz band,
- f_{Tm} will interfere with the TV receiver as seen from Eq. (7.9-3).
- This interference region is called the *image interference region*.

Case 2. When the cell site transmitter is located near a TV receiver

$$2f_{Rc} - f_{T,TV} = f_{Tc} \quad (7.9-4)$$

then $f_{Rc} = f_{Tc} - 45 \quad (7.9-5)$

and $f_{Tc} = f_{T,TV} + 90 \quad (7.9-6)$

- cell-site transmit frequency f_{Tc} lies in the 870- to 890-MHz band,
- $f_{T,TV}$ lies in the 780- to 800-MHz band,
- f_{Tc} will interfere with the TV receiver, as shown in Eq. (7.9-6).
- This interference region is called the image interference region.

Interference of Cellular Mobile Receivers by *UHF* TV Transmitters

- *Case 1.* Let

$$2f_{Tm} - f_{T,TV} = f_{Rm} \quad (7.9-8)$$

Then $2f_{Tm} = 2(f_{Rm} - 45) \quad (7.9-9)$

and $f_{T,TV} = 2f_{Tm} - f_{Rm} = f_{Rm} - 90 \text{ MHz} \quad (7.9-10)$

- the mobile unit receiver frequency f_{Rm} lies in the 870- to 890-MHz band,
- $f_{T,TV}$, which lies in the 780- to 800-MHz band,
- will interfere with the mobile unit receiver, as shown in Eq. (7.9-10).

Case 2. Let

$$2f_{Rc} - f_{T,TV} = f_{Tc} \quad (7.9-11)$$

Then $f_{Rc} = f_{Tc} - 45 \quad (7.9-12)$

and $f_{Rc} = 2f_{Rc} - f_{T,TV} - 45 = f_{T,TV} + 45 \quad (7.9-13)$

- cell-site receiver frequency f_{Rc} lies in the 825- to 845-MHz band,
- $f_{T,TV}$, which lies in the 780- to 800-MHz band, will interfere with the cell-site receiver as shown in Eq. (7.9-13).

- Case 3. When a mobile receiver approaches a TV transmitter, it is easy to find that transmission from the TV station will not interfere with the reception at the mobile receiver.

Case 4. When the cell-site receiver is only 1 mi or less away from the TV station, interference may result.

- when the cell site is very close to the TV station, the interference decreases as a result of the two vertical narrow beams pointing at different elevation levels.
- For this reason it is advisable to mount a cell- site antenna in the same vicinity as the TV station antenna if the problems of shielding and grounding can be controlled.

Long-Distance Interference

- *Overwater Path*
- *Overland Path*

Power Control

Who Controls the Power Level?

- The power level can be controlled only by the mobile transmitting switching office (MTSO), not by the mobile units
- there can be only limited power control by the cell sites as a result of system limitations.

Use of Parasitic Elements

- Interference at the cell site can sometimes be reduced by using parasitic elements, creating a desired pattern in a certain direction.
- Currents appearing in several parasitic antennas are caused by radiation from a nearby drive antenna.
- A driven antenna and a single parasite can be combined in several ways.

1. Normal spacing

- Parasitic elements with effective interference reduction. (a) One-quarter wavelength spacing; (b) one-half wavelength spacing; (c) combination of a and b.

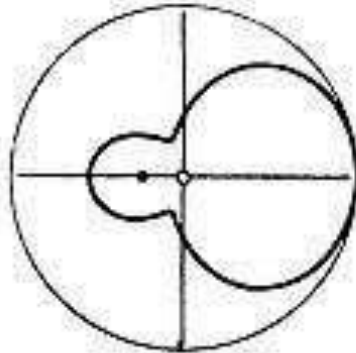

$$g_c = 3.6 \text{ dB}$$

$$g_m = 3.6 \text{ dB}$$

$$z_o = 60.2 + i 32.6 \Omega$$

(a)

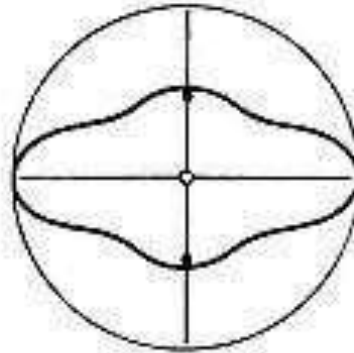

$$g_c = 4.6 \text{ dB}$$

$$g_m = 4.2 \text{ dB}$$

$$z_o = 57.2 - i 22.8 \Omega$$

(b)

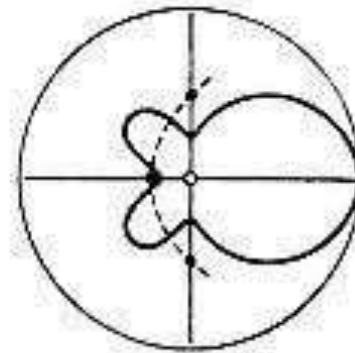

$$g_c = 5.6 \text{ dB}$$

$$g_m = 4.8 \text{ dB}$$

$$z_o = 73.6 + i 43.8 \Omega$$

(c)

- Cell-site directional antennas with a non-wind-resistant structure: a four-element structure that has only one active element.

2. Relatively close spacing

- In relatively close spacing two elements are placed as close as $0.04l$.
- Three cases can be described here

a. The lengths of two elements are identical.

- Two elements, one active and one parasitic, are separated by only 0.04λ .
- At this close spacing, the current flowing in the parasite is very strong.
- The two elements form a null along the y axis in the horizontal
- There is a directive gain of 3 dB relative to a single element.
- The horizontal pattern and the vertical pattern of the closely spaced arrangement are shown

b. The length of the parasite is 5 percent longer than that of the active one.

>> A directive gain of 6 dB is obtained.

c. The length of the parasite is shorter than that of the active one.

>>the parasite acts as a director

>>A gain of 8 dB is obtained.

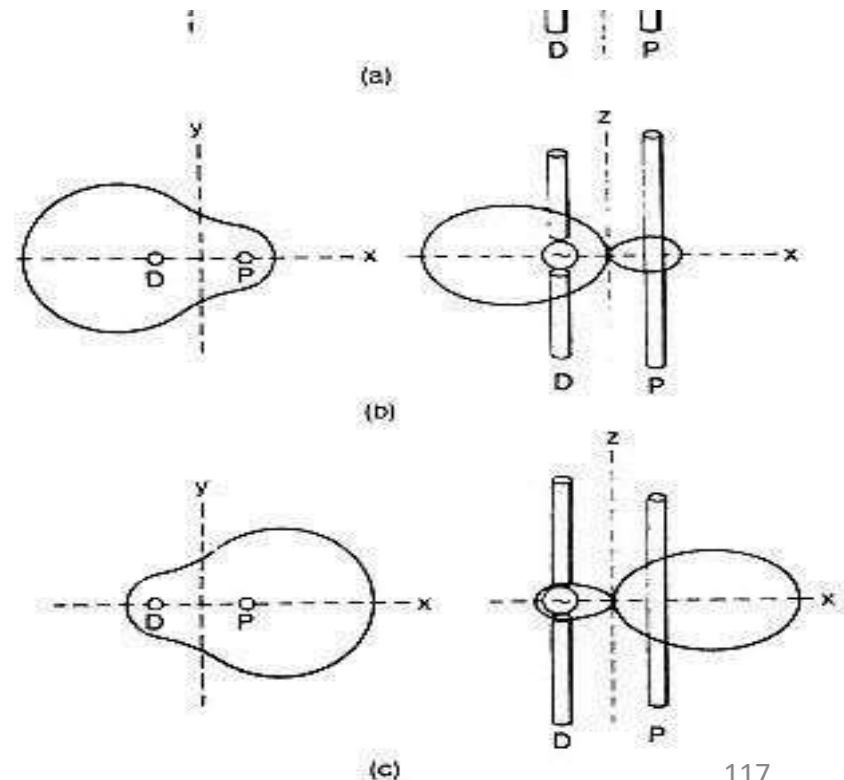

Diversity Receiver

- The diversity scheme applied at the receiving end of the antenna is an effective technique for reducing interference because any measures taken at the receiving end to improve signal performance will not cause additional interference.

Cross Talk

A Unique Characteristic of Voice Channels

- In a mobile cellular system there is a pair of frequencies, occupying a bandwidth of 60 kHz, which we simply call a "channel".
- A frequency of 30 kHz serves a received path, and the other 30 kHz accommodates a transmitted path.

Channel Combiner

- A channel combiner is installed at each cell site.
- Then all the transmitted channels can be combined with minimum insertion loss and maximum signal isolation between channels.
- we can eliminate the channel combiner by letting each channel feed to its own antenna.
- Then a 16-channel site will have 16 antennas for operation
- It is an economical and a physical constraint.

Different kinds of channel combiners.

(a) Fixed-tuned combiner,

(b) tunable combiner,

(c) ring combiner.

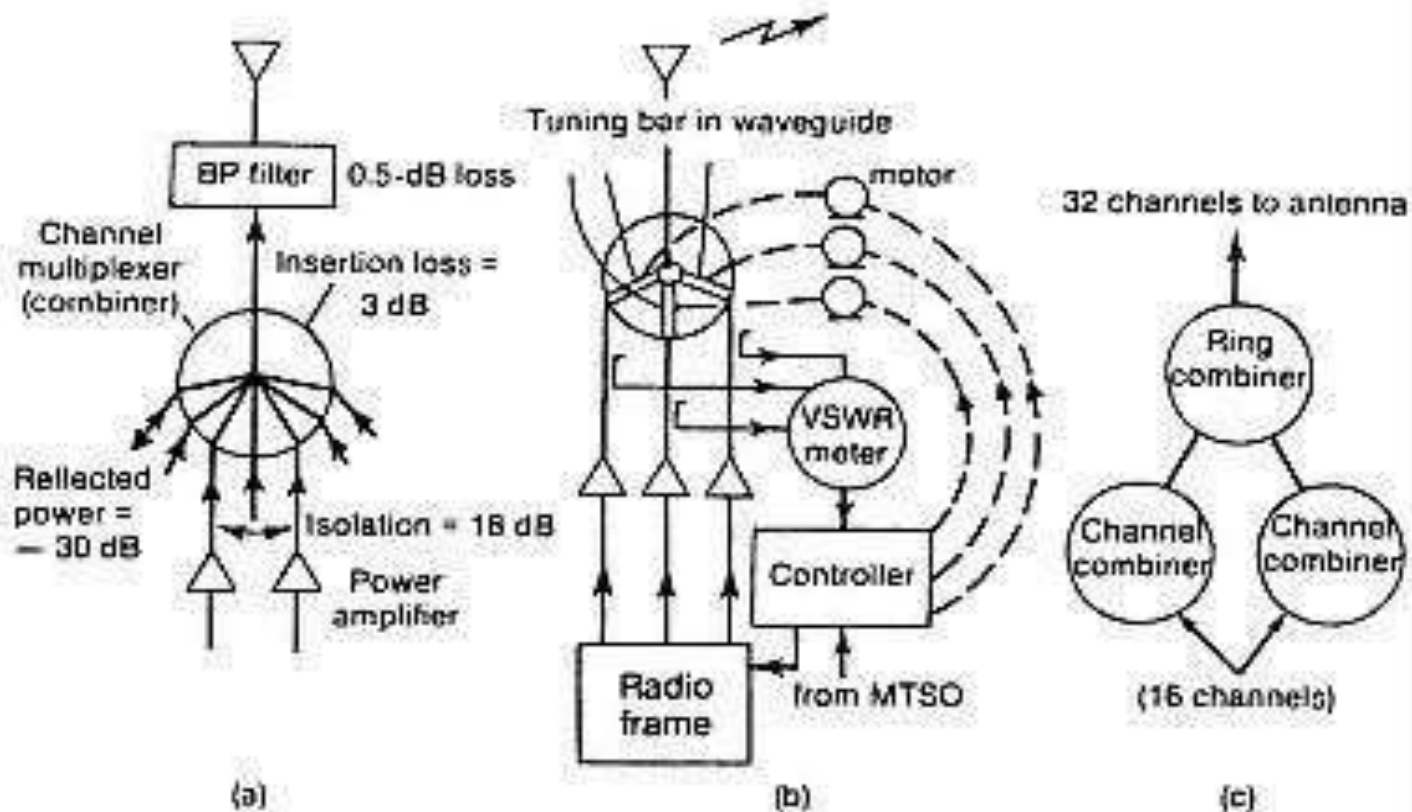

UNIT-III

CELL COVERAGE FOR SIGNALAND TRAFFIC

- *GENERAL INTRODUCTION*
- *OBTAINING THE MOBILE POINT-TO-POINT MODEL (LEE MODEL)*
- *PROPAGATION OVER WATER OR FLAT OPEN AREA*
- *FOLIAGE LOSS*
- *PROPAGATION IN NEAR-IN DISTANCE*
- *LONG-DISTANCE PROPAGATION*
- *PATH LOSS FROM A POINT-TO-POINT PREDICTION MODEL*
- *CELL-SITE ANTENNA HEIGHTS AND SIGNAL COVERAGE CELLS*
- *MOBILE-TO-MOBILE PROPAGATION*

GENERAL INTRODUCTION

Cell coverage can be based on signal coverage or on traffic coverage.

We have to examine the service area as occurring in one of the following environments:

Human-made structures

In a building area In an open area

In a suburban area

In an urban area

Natural terrains Over flat terrain Over hilly terrain Over water

Through foliage areas

Ground Incident Angle and Ground Elevation Angle

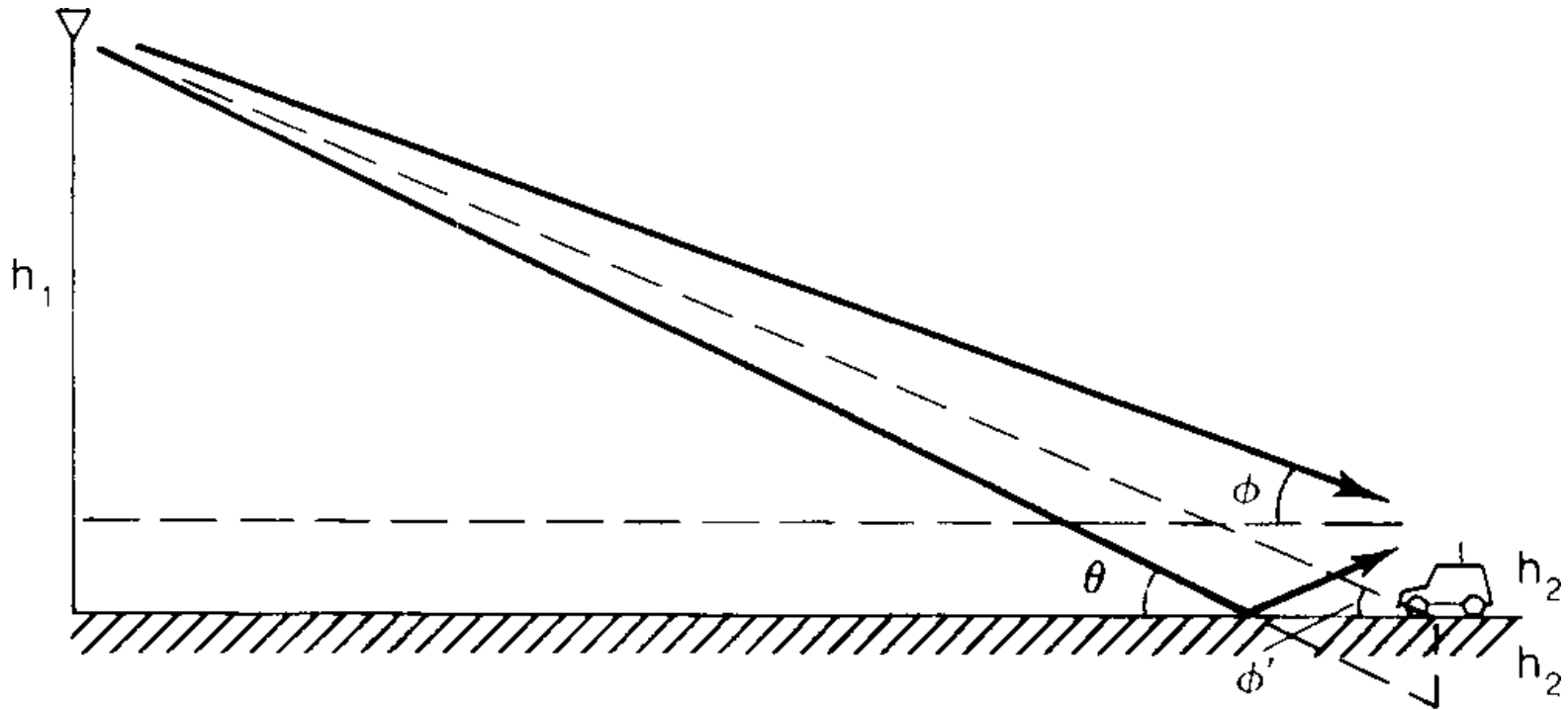

θ is the incident angle
 ϕ is the elevation angle

A coordinate sketch in a flat terrain.

The ground incident angle ϑ is the angle of wave arrival incidental pointing to the ground.

The ground elevation angle φ is the angle of wave arrival at the mobile unit.

Ground Reflection Angle and Reflection Point

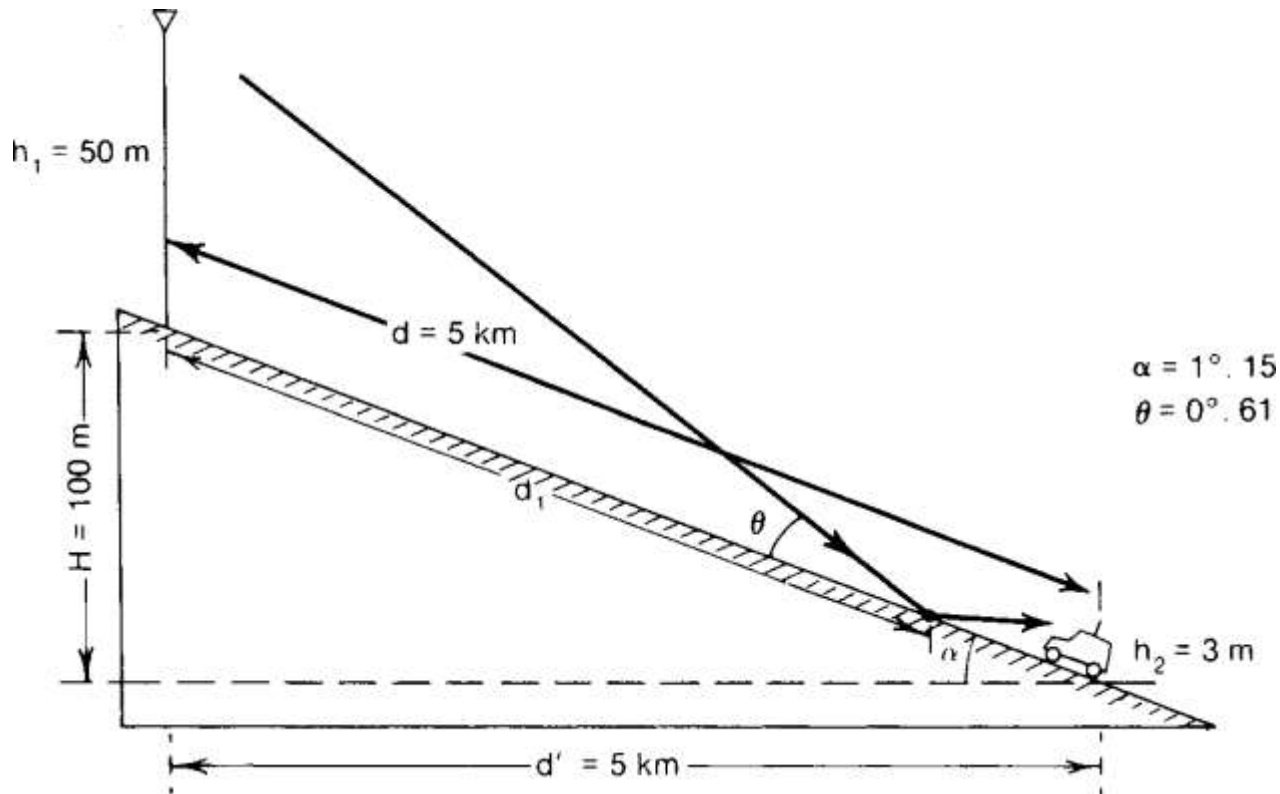

A coordinate sketch in a hilly terrain.

THE MOBILE POINT-TO-POINT MODEL (LEE MODEL)

This mobile point-to-point model is obtained in three steps:

- (1) generate a standard condition.
- (2) obtain an area-to-area prediction model.
- (3) obtain a mobile point-to-point model using the area-to-area model as a base.

OBTAIN PATH LOSS FROM A POINT-TO-POINT PREDICTION MODEL: A GENERAL APPROACH

- Finding the Antenna-Height Gain

What will Δh be for a 6-dB gain above h_1 ?

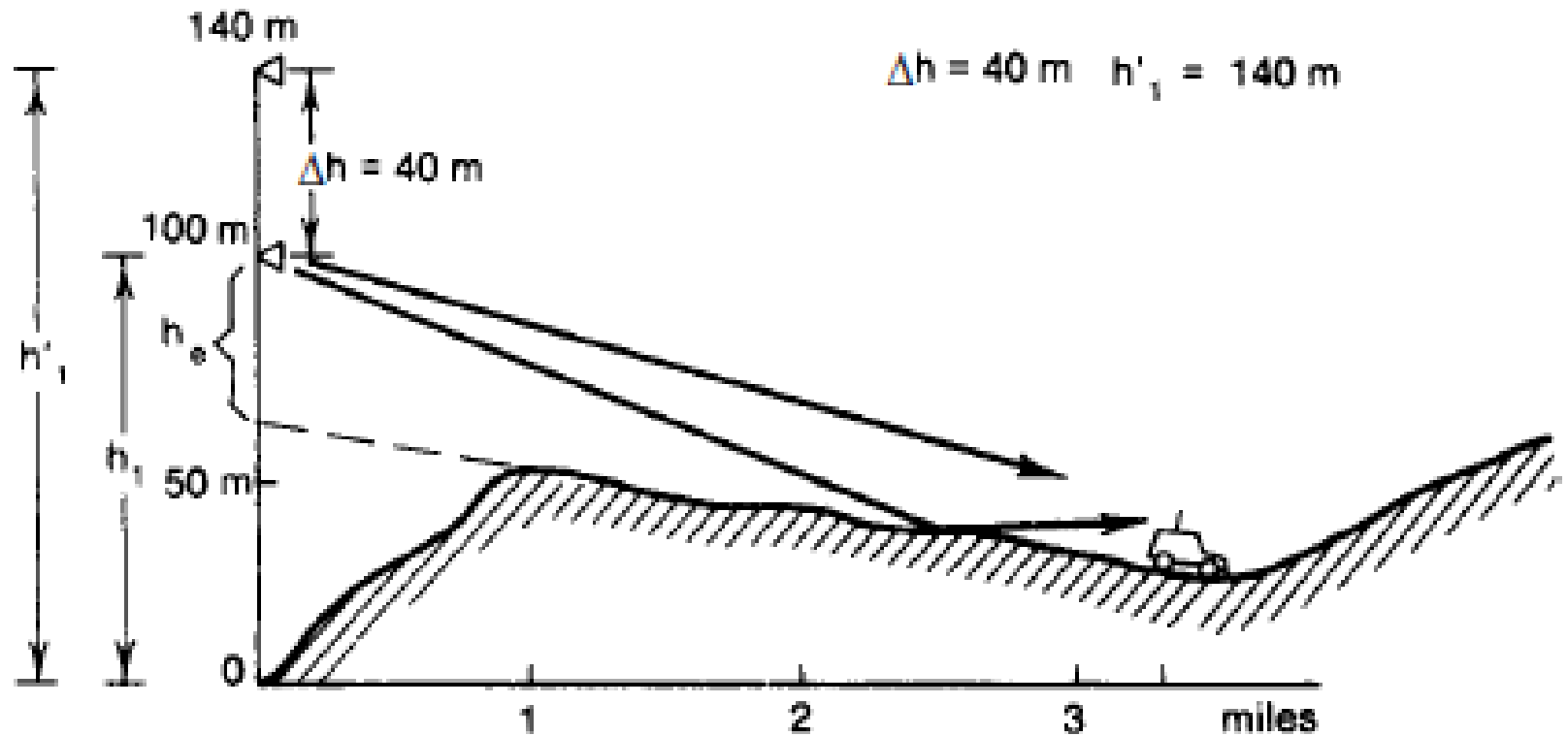

(a)

Finding the Antenna-Height Gain

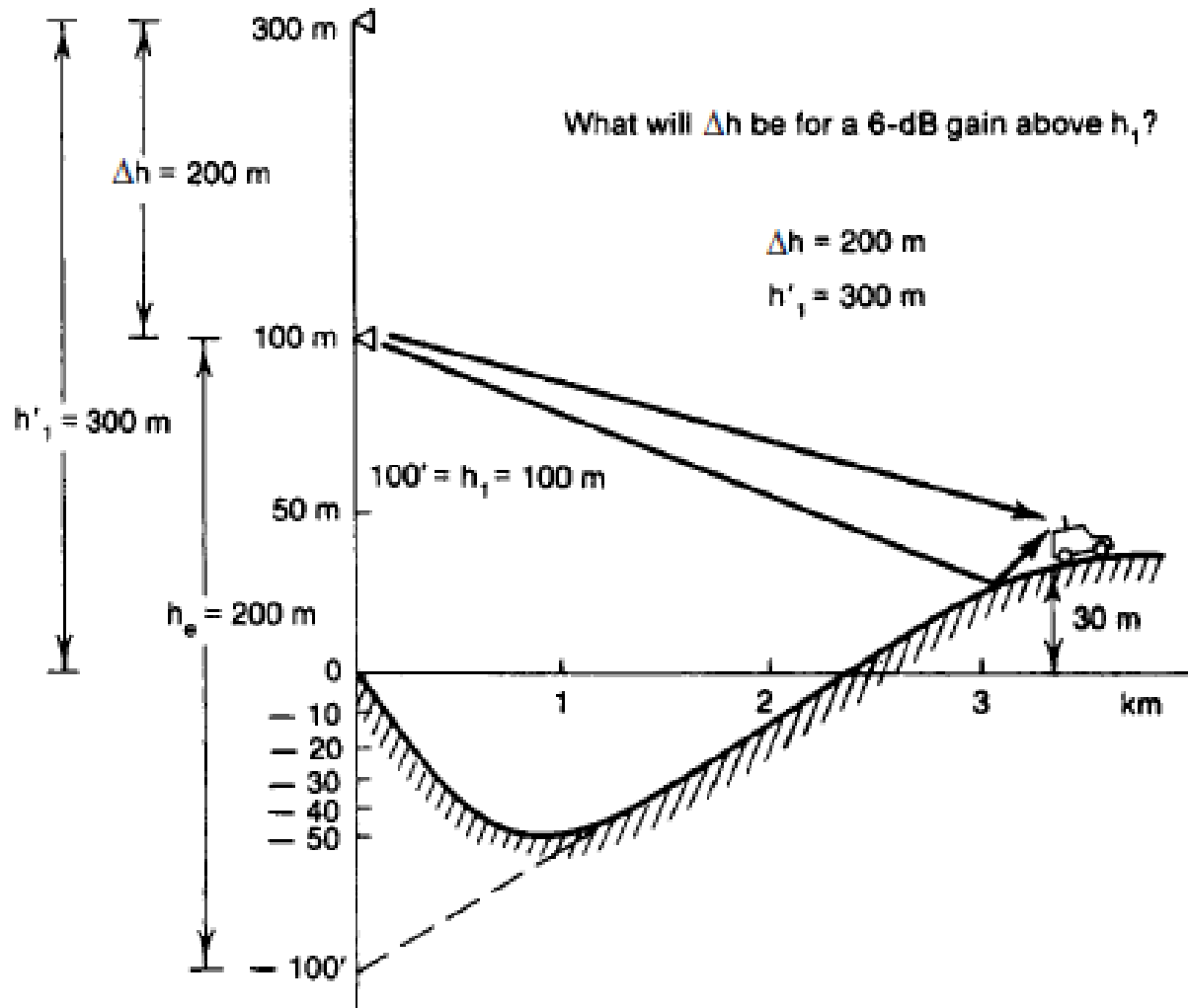

(b)

Antenna Height Gain

$$G = 20 \log \frac{h_e}{h_1}$$

Then the ΔG from Fig. 8.14*a* is

$$\Delta G = 20 \log \frac{40}{100} = -8 \text{ dB} \quad (\text{a negative gain in Fig. 8.14a})$$

The ΔG from Fig. 8.14*b* is

$$\Delta G = 20 \log \frac{200}{100} = 6 \text{ dB} \quad (\text{a positive gain in Fig. 8.14b})$$

Another Physical Explanation of Effective Antenna Height

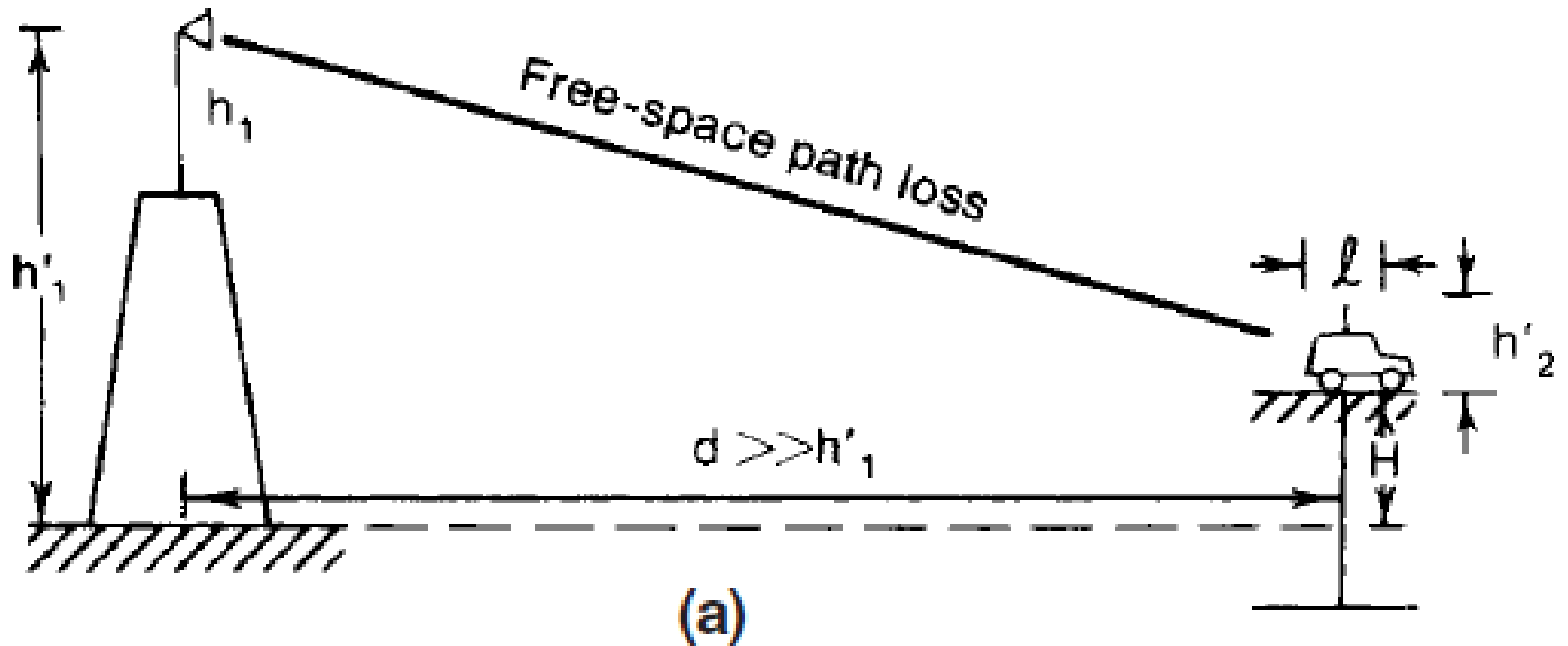

Another Physical Explanation of Effective Antenna Height

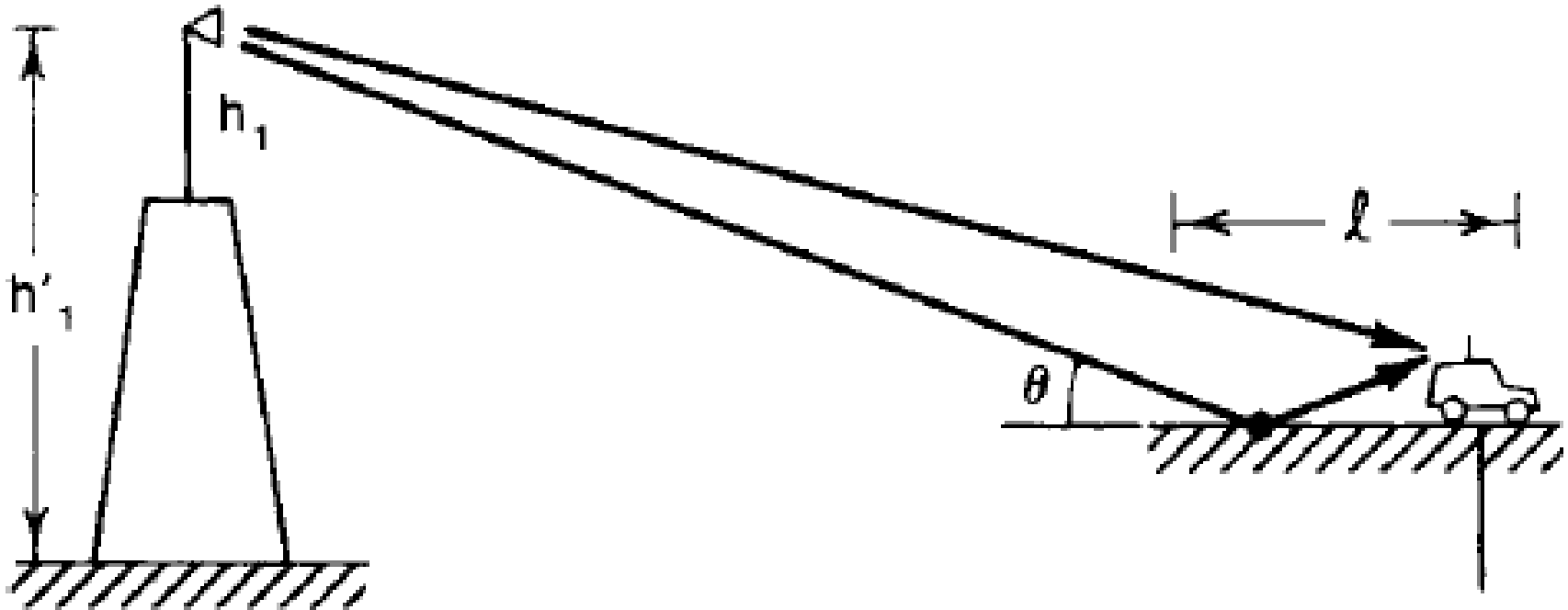

(b)

Another Physical Explanation of Effective Antenna Height

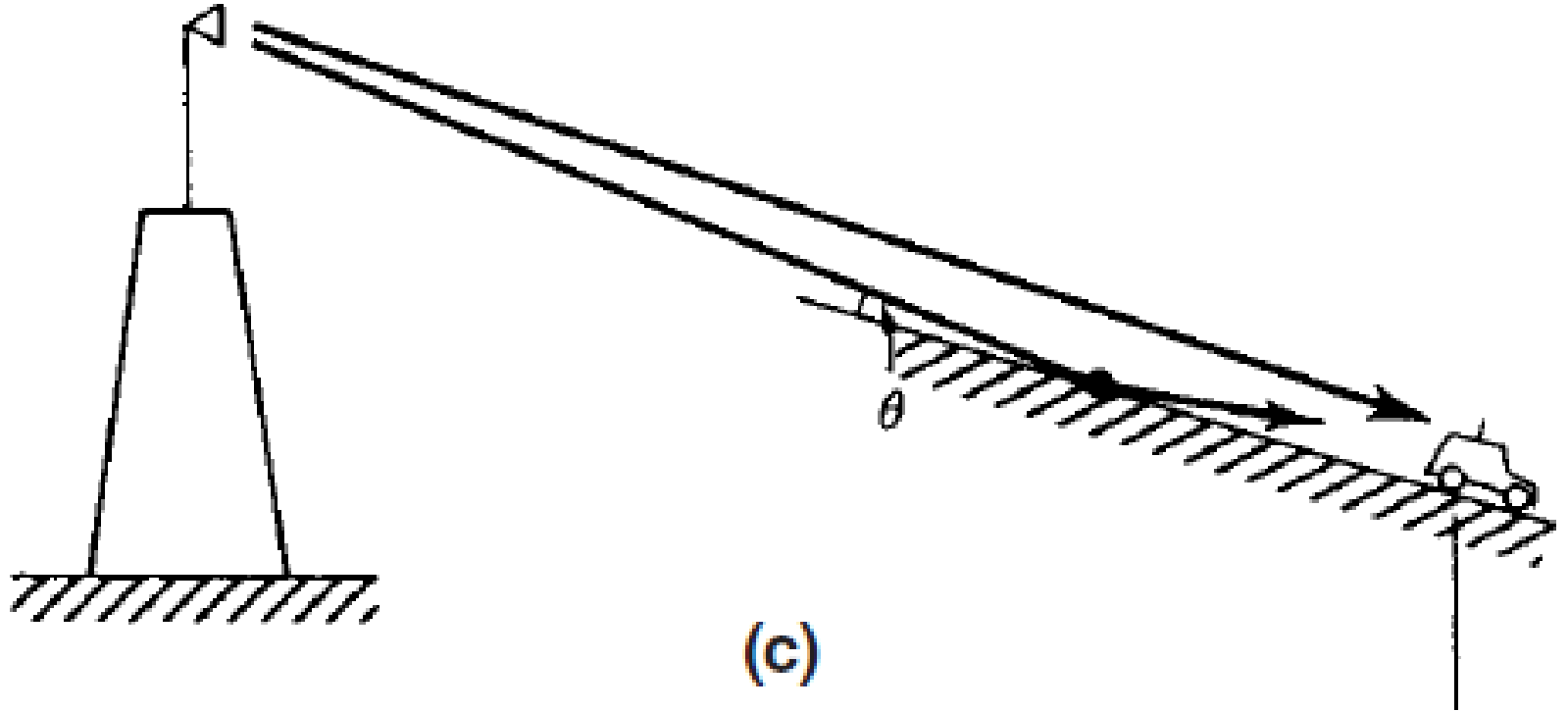

Man-made environment

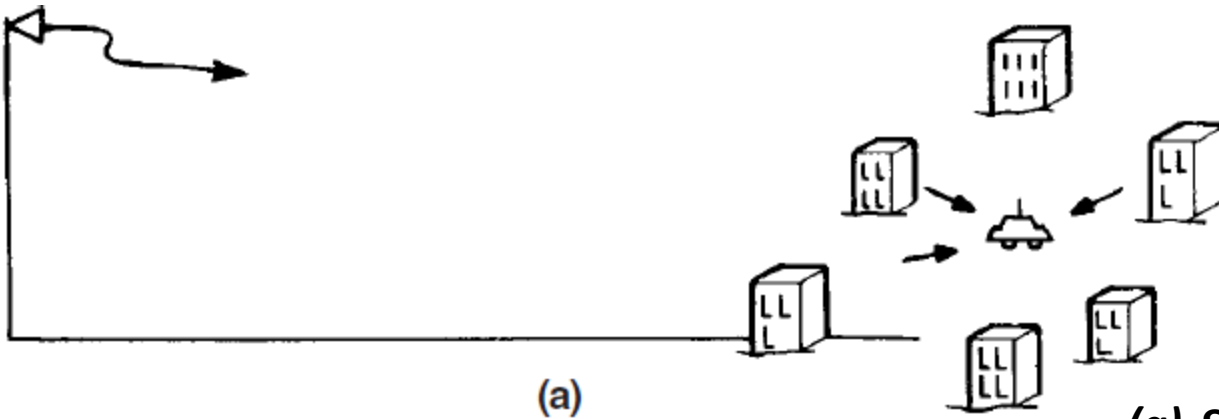

(a)

*(a) Sparse man-made structures.
(b) Dense man-made structures.*

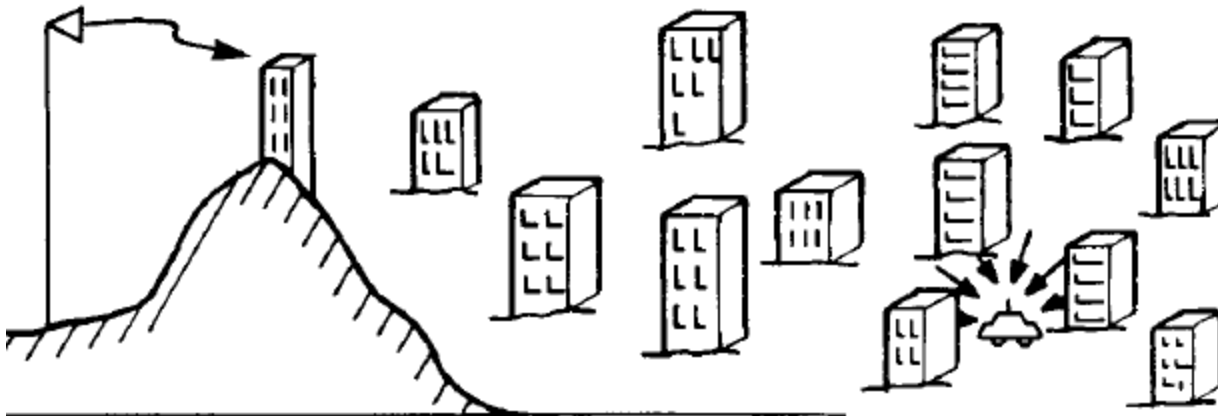

(b)

Illustration of the terrain effect on the effective antenna gain at each position.

(a) Hilly terrain contour.

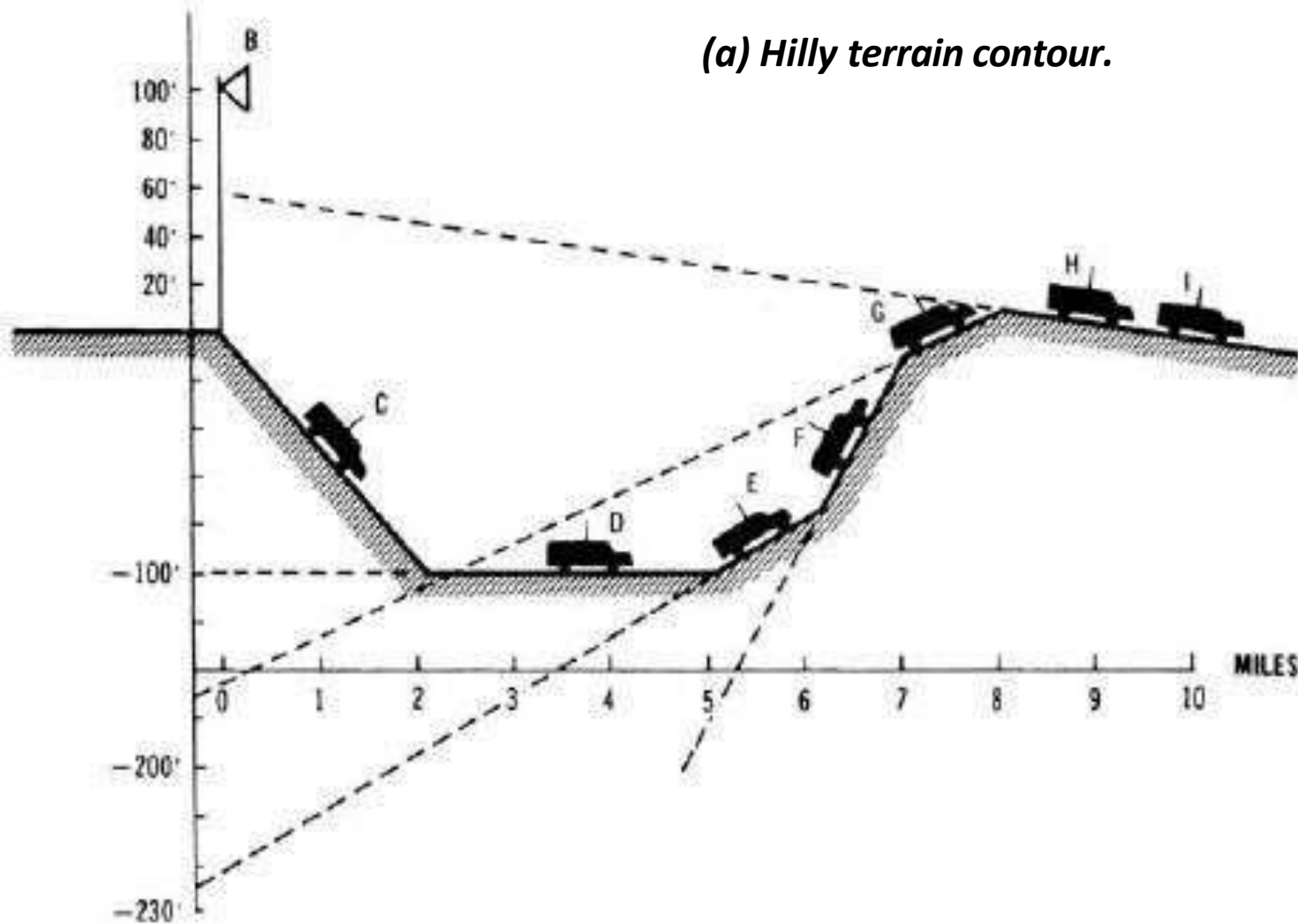

(a)

Illustration of the terrain effect on the effective antenna gain at each position

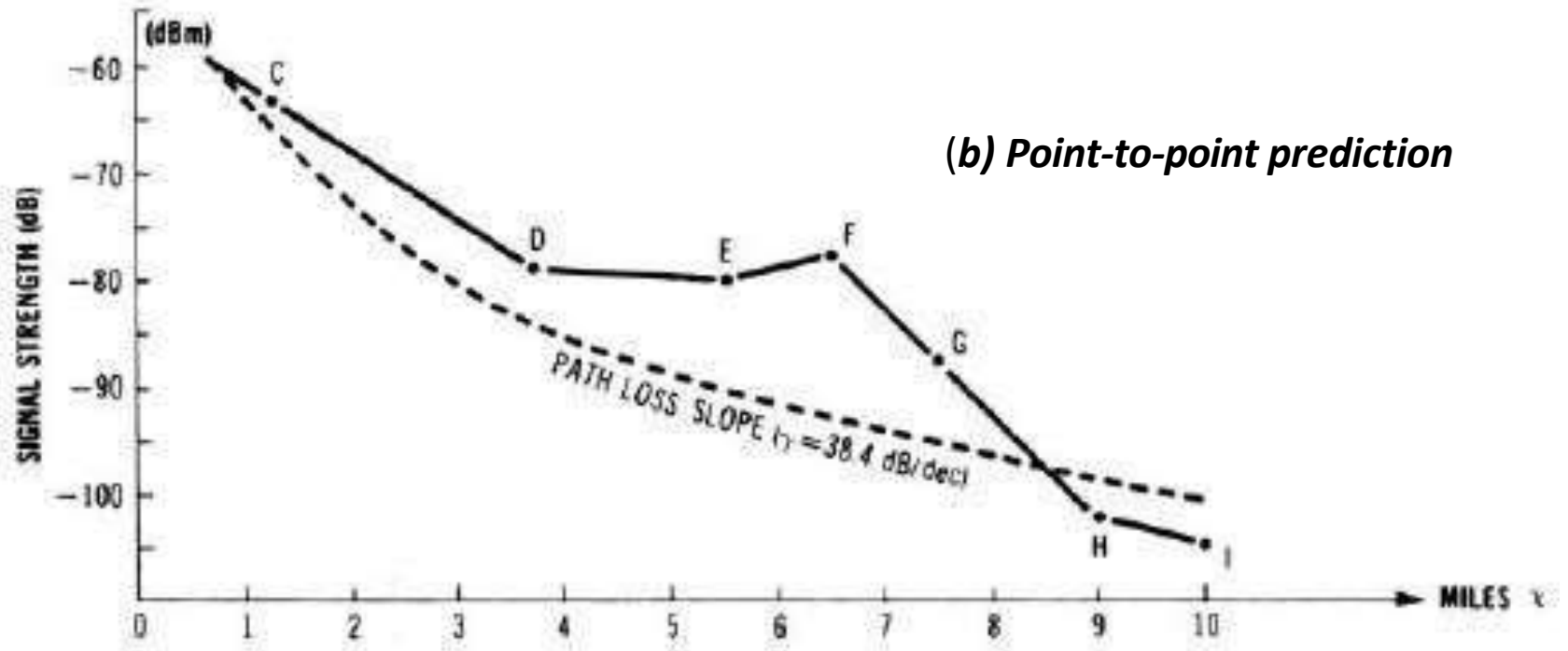

(b)

General Formula of Lee Model

- **1. *Direct-wave case.***
 - The effective antenna height is a major factor which varies with the location of the mobile unit while it travels.
- **2. *Shadow case.***
 - No effective antenna height exists. The loss is totally due to the knife-edge diffraction loss.
- **3. *Over-the-water condition.***
 - The free space path-loss is applied.

General Formula of Lee Model

We form the model as follows:

$$P_r = \begin{cases}
 \text{Nonobstructive path} \\
 = \underbrace{P_{r_0} - \gamma \log \frac{r}{r_0}}_{\text{By human-made structure}} + \underbrace{20 \log \frac{h'_e}{h_1} + \alpha}_{\text{By terrain contour}} \\
 \\
 \text{Obstructive path} \\
 = P_{r_0} - \gamma \log \frac{r}{r_0} + 20 \log \frac{h''_e}{h_1} + L + \alpha \\
 = \underbrace{P_{r_0} - \gamma \log \frac{r}{r_0}}_{\text{By human-made structure}} + \underbrace{L + \alpha}_{\text{By terrain contour}} \text{ (when } h''_e \approx h_1) \\
 \\
 \text{Land-to-mobile over water} = \text{a free-space formula}
 \end{cases}$$

Merits of Lee Model

- The point-to-point model is very useful for designing a mobile cellular system with a radius for each cell of 10 mi or less.
- This point-to-point prediction can be used to provide overall coverage of all cell sites and to avoid co-channel interference.
- The occurrence of handoff in the cellular system can be predicted more accurately.
- The point-to-point prediction model is a basic tool that is used to generate
 - a signal coverage map
 - an interference area map
 - a handoff occurrence map
 - or an optimum system design configuration

A Standard Condition

To generate a standard condition and provide correction factors, we have used the standard conditions shown on the left side and the correction factors on the right side of Table

Generating a Standard Condition

Standard Condition	Correction Factors*
At the Base Station	
Transmitted power $P_t = 10$ W (40 dBm)	$\alpha_1 = 10 \log \frac{P'_t}{10}$
Antenna height $h_1 = 100$ ft (30 m)	$\alpha_2 = 20 \log \frac{h'_1}{h_1}$
Antenna gain $G_t = 6$ dB/dipole	$\alpha_3 = G'_t - 6$
At the Mobile Unit	
Antenna height, $h_2 = 10$ ft (3 m)	$\alpha_4 = 10 \log \frac{h'_2}{h_2}$
Antenna gain, $G_m = 0$ dB/dipole	$\alpha_5 = G'_m$

*All the parameters with primes are the new conditions.

Effect of the Human-Made Structures.

Because the terrain configuration of each city is different, and the human-made structure of each city is also unique.

The way to factor out the effect due to the terrain configuration from the man-made structures is to work out a way to obtain the path loss curve for the area.

The path loss curve obtained on virtually flat ground indicates the effects of the signal loss due to solely human-made structures.

We may have to measure signal strengths at those high spots and also at the low spots surrounding the cell sites.

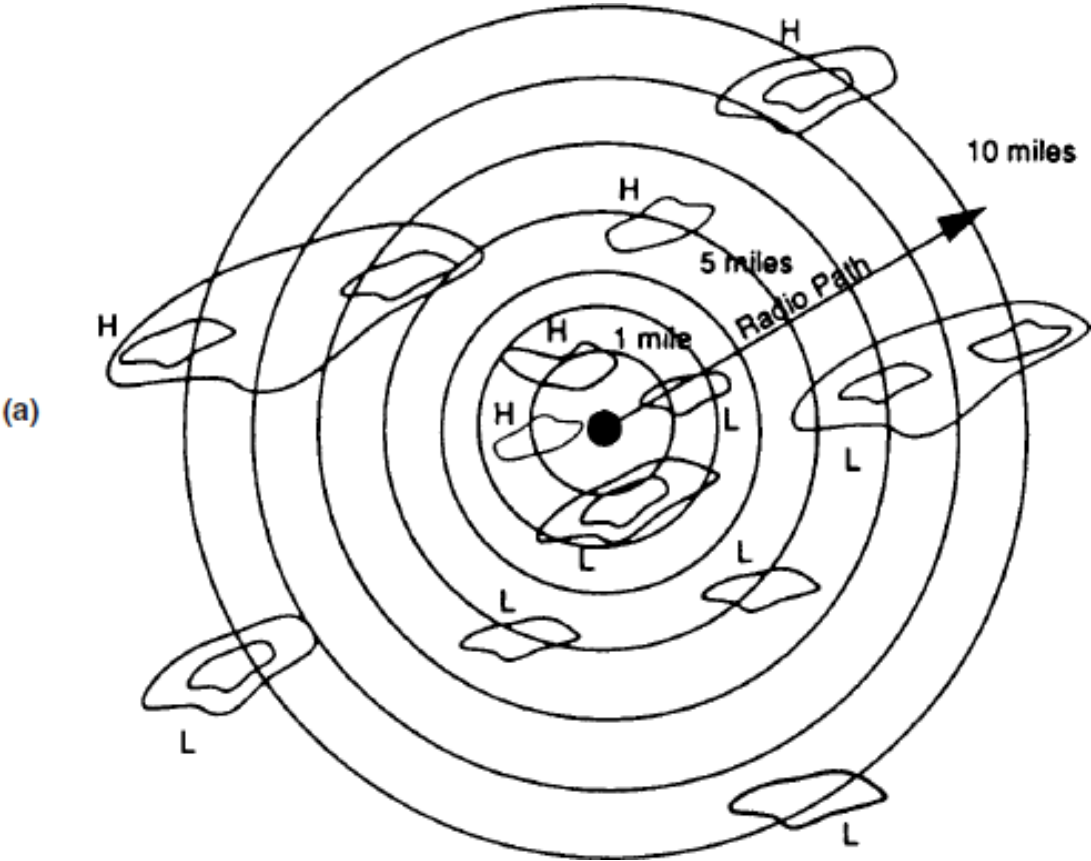

Propagation path loss curves for human-made structures.
(a) For selecting measurement areas

Then the average path loss slope, which is a combination of measurements from high spots and low spots along different radio paths in a general area, represents the signal received as if it is from a flat area affected only by a different local human-made structured environment.

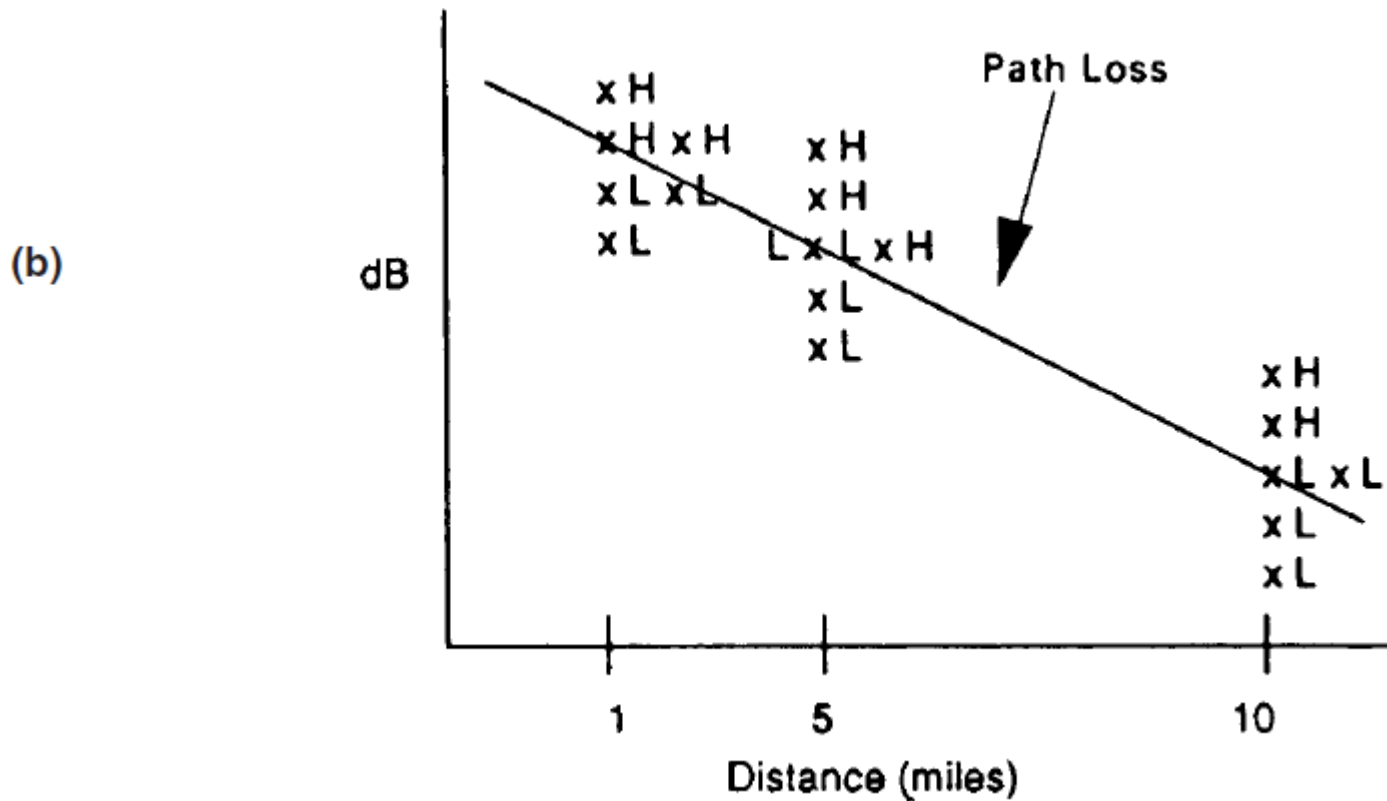

(b) path loss phenomenon.

Therefore, the differences in area-to-area prediction curves are due to the different manmade structures.

The measurements made in urban areas are different from those made in suburban and open areas.

Any area-to-area prediction model can be used as a first step toward achieving the point-to-point prediction model.

Area-to-area prediction model which is described here can be represented by two parameters:

- (1) the 1-mi (or 1-km) intercept point
- (2) the path-loss slope.

The 1-mi intercept point is the power received at a distance of 1 mi from the transmitter.

There are **two** general approaches to finding the values of the two parameters experimentally.

1. Compare the area of interest with an area of similar human-made structures which presents a curve as shown.

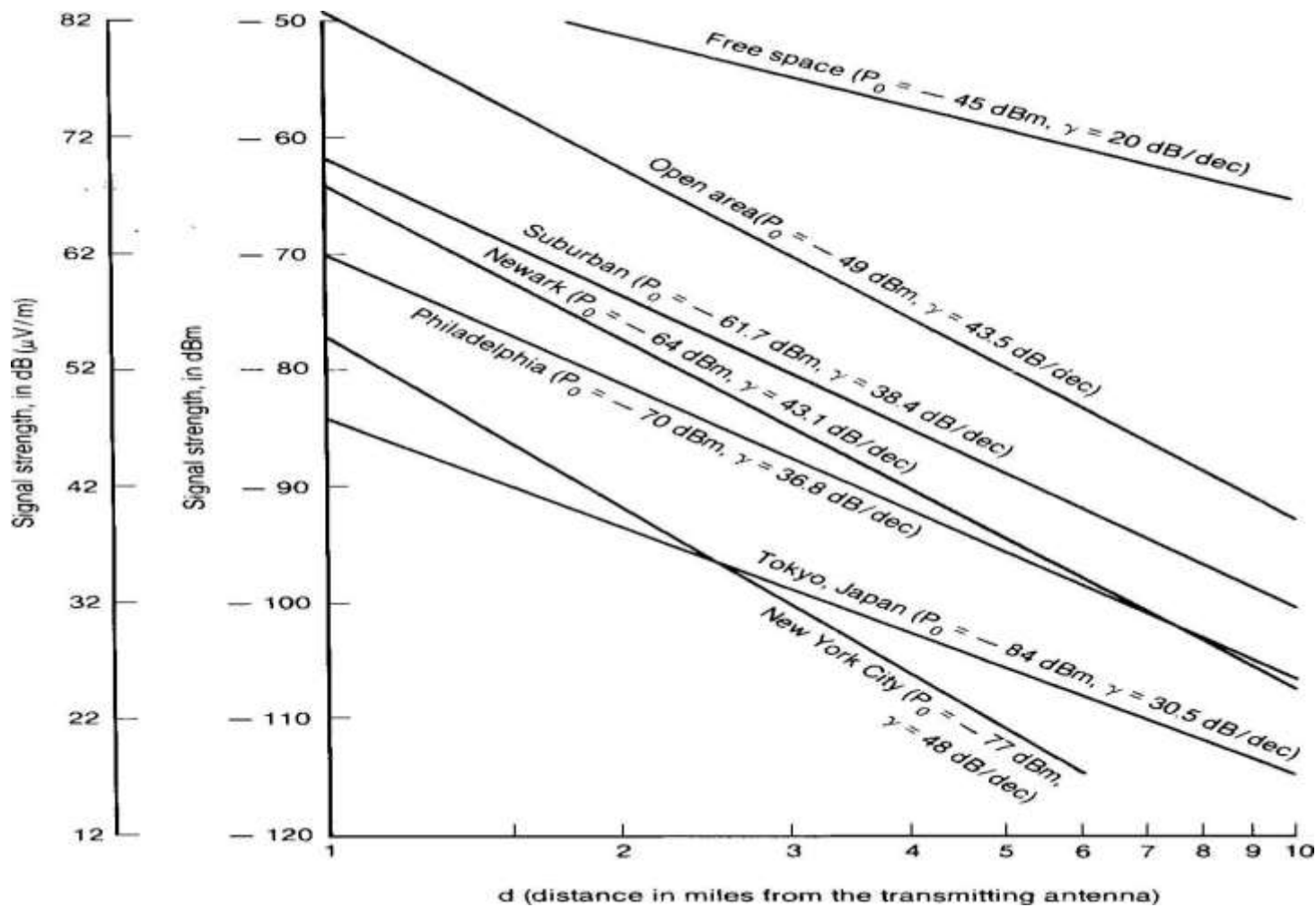

(c) Propagation path loss in different cities.

2. If the human-made structures of a city are different from the cities listed in previous figure, a simple measurement should be carried out.

Set up a transmitting antenna at the center of a general area.

As long as the building height is comparable to the others in the area, the antenna location is not critical.

Take six or seven measured data points around the 1-mi intercept and around the 10-mi boundary based on the high and low spots.

Then compute the average of the 1 mi data points and of the 10 mi data points.

By connecting the two values, the path-loss slope can be obtained.

If the area is very hilly, then the data points measured at a given distance from the base station in different locations can be far apart.

In this case, we may take more measured data points to obtain the average path-loss slope.

If the terrain of the hilly area is generally sloped, then we have to convert the data points that were measured on the sloped terrain to a flat terrain in that area.

The conversion is based on the effective antenna-height gain as

$$\Delta G = \text{effective antenna-height gain} = 20 \log \frac{h_e}{h_1}$$

where h_1 is the actual height and h_e is the effective antenna height at either the 1- or 10-mi locations.

Path-loss Phenomena

The plotted curves shown in the previous figure *have different 1-mi intercepts and different slopes.*

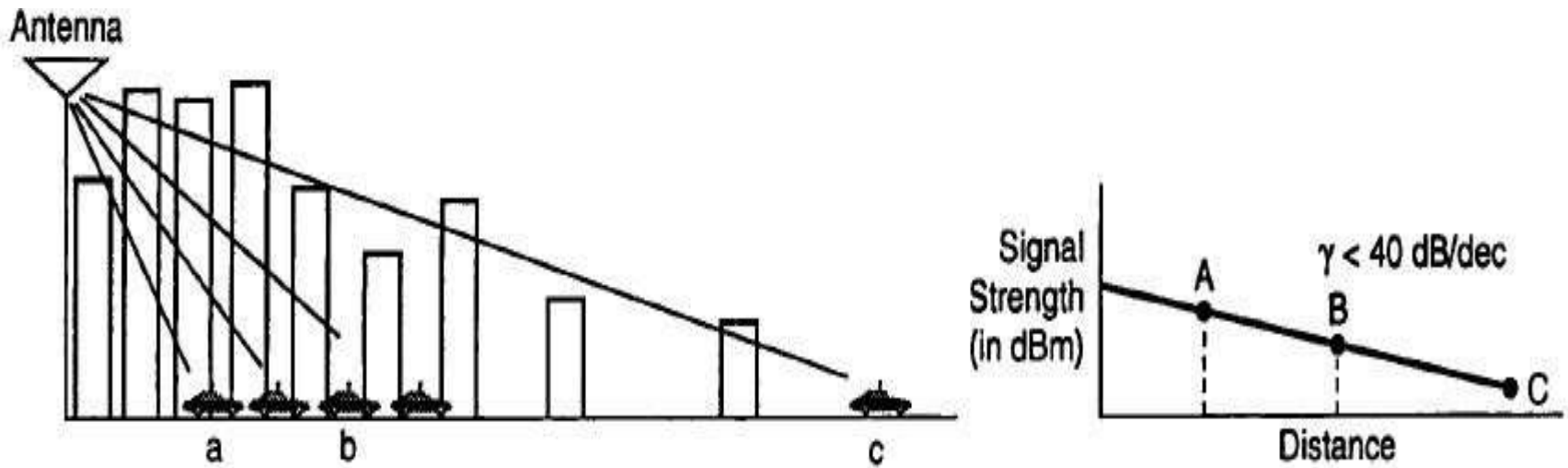

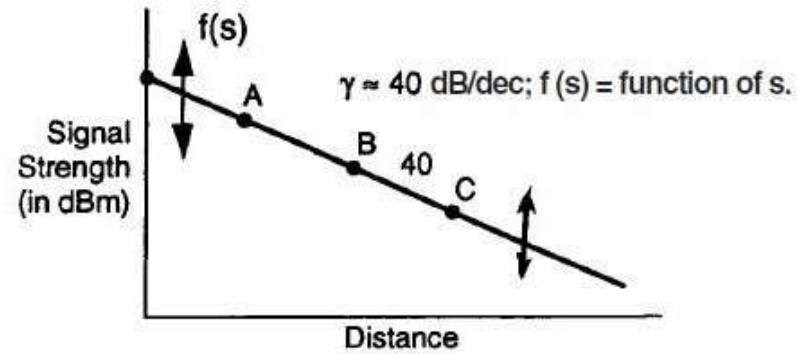
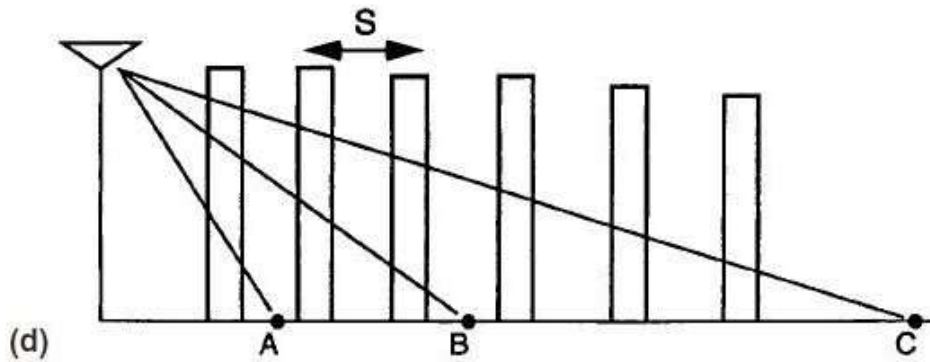
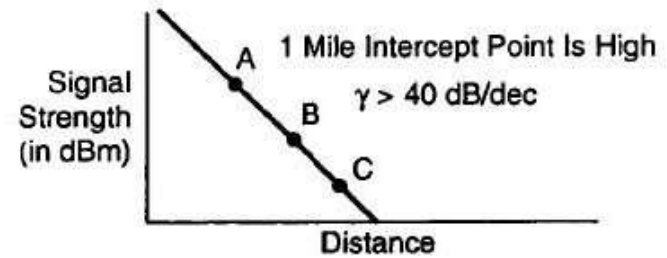
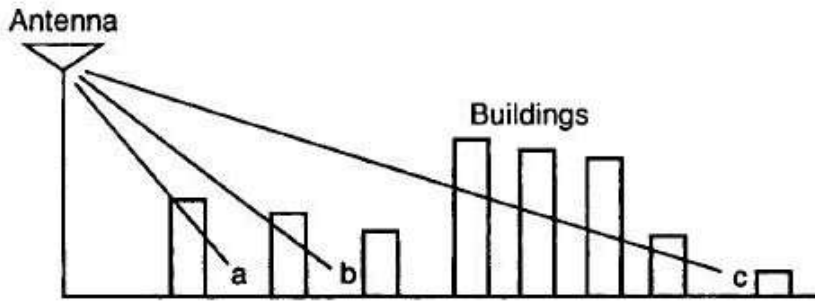

(d) Explanation of the path-loss phenomenon.

The Phase Difference between a Direct Path and a Ground-Reflected Path

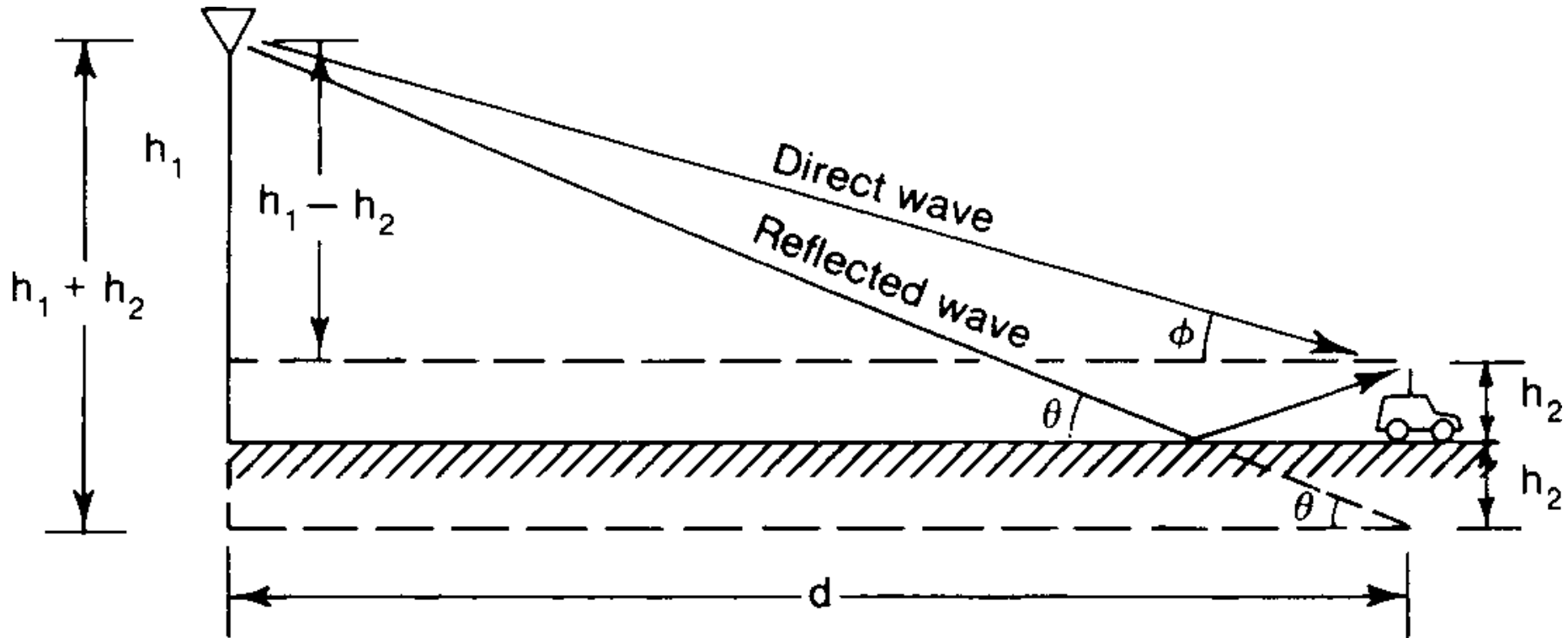

A simple model.

Based on a direct path and a ground-reflected path, where a direct path is a line-of-sight (LOS) path with its received power

$$P_{\text{Los}} = P_0 \left(\frac{1}{4\pi d/\lambda} \right)^2$$

and a ground-reflected path with its reflection coefficient and phase changed after reflection, the sum of the two wave paths can be expressed as:

$$P_r = P_0 \left(\frac{1}{4\pi d/\lambda} \right)^2 \left| 1 + a_v e^{j\Delta\phi} \right|^2$$

where

- a_v = the reflection coefficient
- φ = the phase difference between a direct path and a reflected path
- P_0 = the transmitted power
- d = the distance
- λ = the wavelength

In a mobile environment $\alpha v = -1$ because of the small incident angle of the ground wave caused by a relatively low cell-site antenna height. Thus,

$$P_r = P_0 \left(\frac{1}{4\pi d/\lambda} \right)^2 \left| 1 - \cos \Delta\phi - j \sin \Delta\phi \right|^2$$

$$= P_0 \frac{2}{(4\pi d/\lambda)^2} (1 - \cos \Delta\phi) = P_0 \frac{4}{(4\pi d/\lambda)^2} \sin^2 \frac{\Delta\phi}{2}$$

where

$$\Delta\phi = \beta \Delta d$$

and Δd is the difference, $\Delta d = d_1 - d_2$ from **figure**

$$d_1 = \sqrt{(h_1 + h_2)^2 + d^2}$$

and

$$d_2 = \sqrt{(h_1 - h_2)^2 + d^2}$$

Because Δd is much smaller than either d_1 or d_2 ,

$$\Delta\phi = \beta \Delta d \approx \frac{2\pi}{\lambda} \frac{2h_1 h_2}{d}$$

Then the received power of becomes :

$$P_r = P_0 \frac{\lambda^2}{(4\pi)^2 d^2} \sin^2 \frac{4\pi h_1 h_2}{\lambda d}$$

If φ is less than 0.6 rad, then $\sin(\varphi/2) \approx \varphi/2$, $\cos(\varphi/2) \approx 1$ and equation simplifies to

$$P_r = P_0 \frac{4}{16\pi^2 (d/\lambda)^2} \left(\frac{2\pi h_1 h_2}{\lambda d} \right)^2 = P_0 \left(\frac{h_1 h_2}{d^2} \right)^2$$

From Equation, we can deduce two relationships as follows:

$$\Delta P = 40 \log \frac{d_1}{d_2} \quad (\text{a } 40 \text{ dB/dec path loss})$$

$$\Delta G = 20 \log \frac{h_1'}{h_1} \quad (\text{an antenna height gain of } 6 \text{ dB/oct})$$

where ΔP is the power difference in decibels between two different path lengths and ΔG is the gain (or loss) in decibels obtained from two different antenna heights at the cell site.

$$\Delta G' = 10 \log \frac{h_2'}{h_2} \quad (\text{an antenna-height gain of 3 dB/oct})$$

PROPAGATION OVER WATER OR FLAT OPEN AREA

Propagation over water or flat open area is becoming a big concern because it is very easy to interfere with other cells if we do not make the correct arrangements. Interference resulting from propagation over the water can be controlled if we know the cause.

the permittivity ϵ_r *water and fresh water are the same, but the conductivities of seawater and fresh water are different.*

The ϵ_c (seawater) = $80 - j84$ and ϵ_c (fresh water) = $80 - j0.021$.

Based upon the reflection coefficients formula *with a small incident angle*, both the reflection coefficients for horizontal polarized waves and vertically polarized waves approach 1.

Because the 180° phase change occurs at the ground reflection point, the reflection coefficient is -1 .

Below shown are the two antennas, one at the cell site and the other at the mobile unit, are well above sea level, two reflection points are generated.

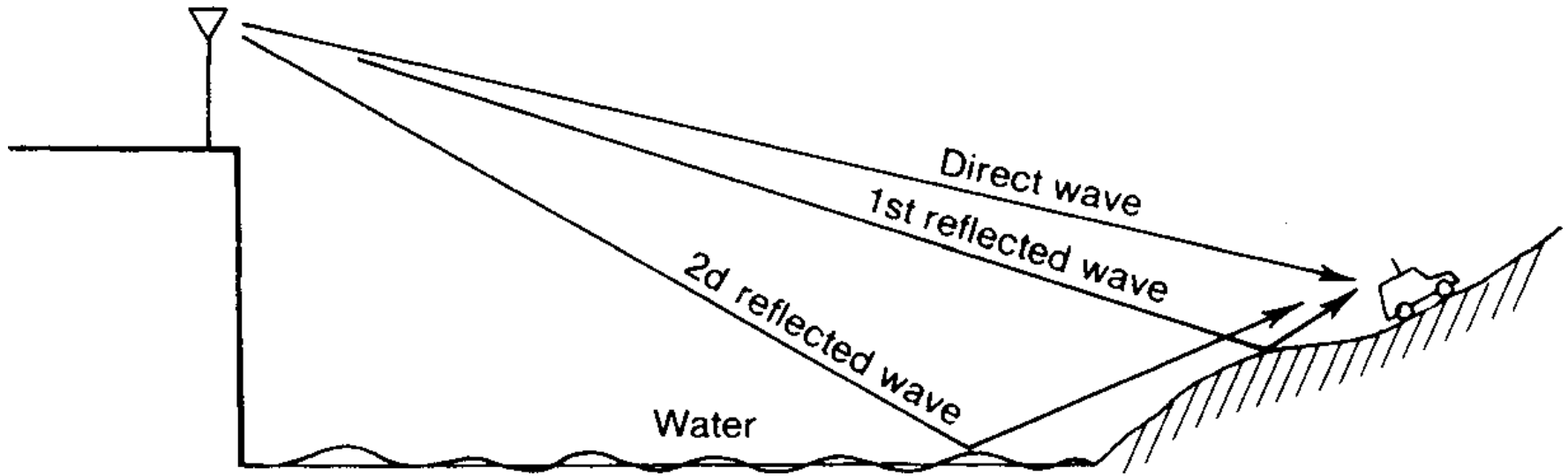

A model for propagation over water.

The formula to find the field strength under the circumstances of a fixed point-to-point transmission and a land-mobile transmission over a water or flat open land condition.

Between Fixed Stations

The point-to-point transmission between the fixed stations over the water or flat open land can be estimated as follows. The received power P_r can be expressed as

$$P_r = P_t \left(\frac{1}{4\pi d/\lambda} \right)^2 \left| 1 + a_v e^{-j\phi_v} \exp(j\Delta\phi) \right|^2$$

where

P_t = the transmitted power

d = distance between two stations

λ = wavelength

a_v, ϕ_v = amplitude and phase of a complex reflection coefficient, respectively

$\Delta\phi$ is the phase difference caused by the path difference Δd between the direct wave and the reflected wave, or

$$\Delta\phi = \beta\Delta d = \frac{2\pi}{\lambda}\Delta d$$

$$P_0 = \frac{P_t}{(4\pi d/\lambda)^2}$$

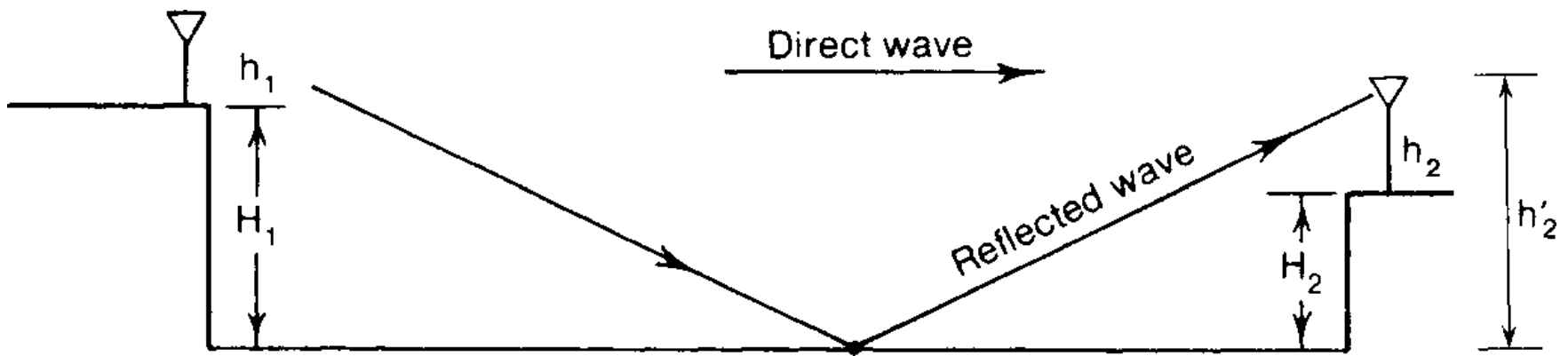

Propagation between two fixed stations over water or flat open land.

The $a_v e^{-j\phi_v}$
formula

are the complex reflection coefficients and can be found from the

$$a_v e^{-j\phi_v} = \frac{\epsilon_c \sin \theta_1 - (\epsilon_c - \cos^2 \theta_1)^{1/2}}{\epsilon_c \sin \theta_1 + (\epsilon_c - \cos^2 \theta_1)^{1/2}}$$

When the vertical incidence is small, ϑ is very small and

$$a_v \approx -1 \quad \text{and} \quad \phi_v = 0$$

And thereafter, the equation then becomes:-

$$\begin{aligned} P_r &= \frac{P_t}{(4\pi d/\lambda)^2} \left| 1 - \cos \Delta\phi - j \sin \Delta\phi \right|^2 \\ &= P_0(2 - 2 \cos \Delta\phi) \end{aligned}$$

as $\Delta\phi$ is a function of Δd and Δd can be obtained from the following calculation. The effective antenna height at antenna 1 is the height above the sea level.

$$h'_1 = h_1 + H_1$$

The effective antenna height at antenna 2 is the height above the sea level.

$$h'_2 = h_2 + H_2$$

where h_1 and h_2 are actual heights and H_1 and H_2 are the heights of hills. In general, both antennas at fixed stations are high, so the reflection point of the wave will be found toward the middle of the radio path. The path difference d can be obtained as

$$\Delta d = \sqrt{(h'_1 + h'_2)^2 + d^2} - \sqrt{(h'_1 - h'_2)^2 + d^2}$$

Because $d \gg h'_1$ and h'_2 , then

$$\Delta d \approx d \left[1 + \frac{(h'_1 + h'_2)^2}{2d^2} - 1 - \frac{(h'_1 - h'_2)^2}{2d^2} \right] = \frac{2h'_1 h'_2}{d}$$

Then, equation becomes

$$\Delta \phi = \frac{2\pi}{\lambda} \frac{2h'_1 h'_2}{d} = \frac{4\pi h'_1 h'_2}{\lambda d}$$

Therefore, we can set up five conditions:

1. $P_r < P_0$. The received power is less than the power received in free space;

$$2 - 2 \cos \Delta\phi < 1 \quad \text{or} \quad \Delta\phi < \frac{\pi}{3}$$

2. $P_r = 0$; that is,

$$2 - 2 \cos \Delta\phi = 0 \quad \text{or} \quad \Delta\phi = \frac{\pi}{2}$$

3. $P_r = P_0$; that is,

$$2 - 2 \cos \Delta\phi = 1 \quad \text{or} \quad \Delta\phi = \pm 60^\circ = \pm \frac{\pi}{3}$$

4. $P_r > P_0$; that is,

$$2 - 2 \cos \Delta\phi > 1 \quad \text{or} \quad \frac{\pi}{3} < \Delta\phi < \frac{5\pi}{3}$$

5. $P_r = 4P_0$; that is,

$$2 - 2 \cos \Delta\phi = \max \quad \text{or} \quad \Delta\phi = \pi$$

Land-to-Mobile Transmission Over Water

There are always two equal-strength reflected waves, one from the water and one from the proximity of the mobile unit, in addition to the direct wave.

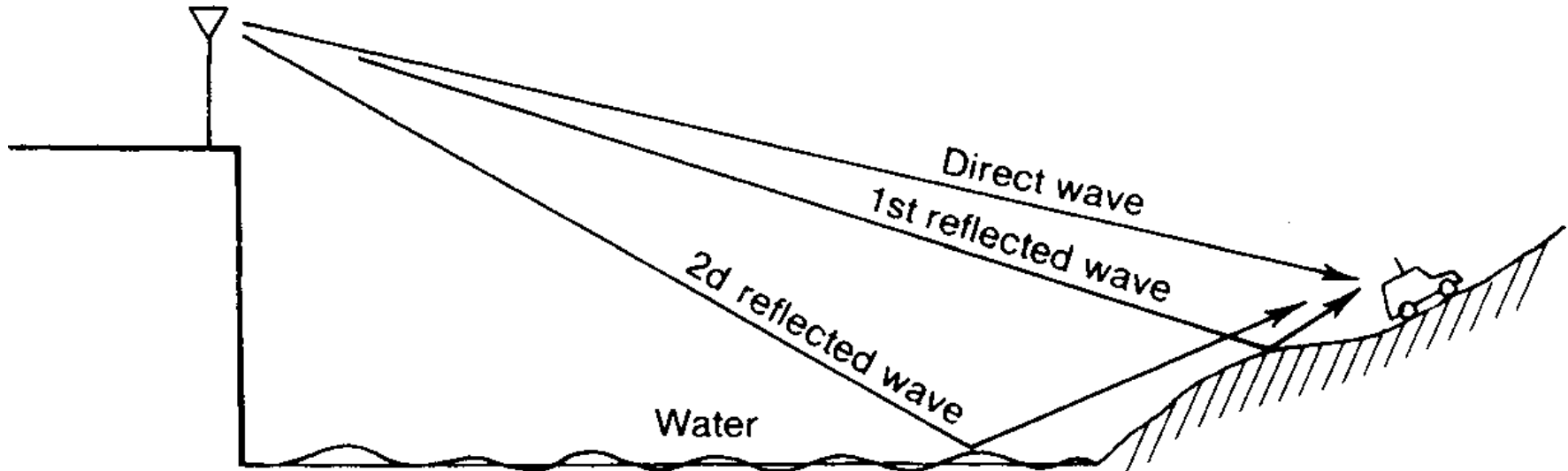

Therefore, the reflected power of the two reflected waves can reach the mobile unit without noticeable attenuation. The total received power at the mobile unit would be obtained by summing three components.

$$P_r = \frac{P_t}{(4\pi d/\lambda)^2} \left| 1 - e^{j\Delta\phi_1} - e^{j\Delta\phi_2} \right|^2$$

Where $\Delta\phi_1$ and $\Delta\phi_2$ are the path-length difference between the direct wave and two reflected waves, respectively. Because $\Delta\phi_1$ and $\Delta\phi_2$ are very small usually for *the* land-to-mobile path, then

$$P_r = \frac{P_t}{(4\pi d/\lambda)^2} \left| 1 - \cos \Delta\phi_1 - \cos \Delta\phi_2 - j(\sin \Delta\phi_1 + \sin \Delta\phi_2) \right|^2$$

Follow the same approximation for the land-to-mobile propagation over water.

$$\cos \Delta\phi_1 \approx \cos \Delta\phi_2 \approx 1 \quad \sin \Delta\phi_1 \approx \Delta\phi_1 \quad \sin \Delta\phi_2 \approx \Delta\phi_2$$

Then,

$$\begin{aligned} P_r &= \frac{P_t}{(4\pi d/\lambda)^2} \left| -1 - j(\Delta\phi_1 + \Delta\phi_2) \right|^2 \\ &= \frac{P_t}{(4\pi d/\lambda)^2} \left[1 + (\Delta\phi_1 + \Delta\phi_2)^2 \right] \end{aligned}$$

In most practical cases, $\Delta\phi_1 + \Delta\phi_2 < 1$; then
equation reduces to

$$(\Delta\phi_1 + \Delta\phi_2)^2$$

$\ll 1$ and the

$$P_r = \frac{P_t}{(4\pi d/\lambda)^2}$$

FOLIAGE LOSS

Foliage loss is a very complicated topic that has many parameters and variations. The sizes of leaves, branches, and trunks, the density and distribution of leaves, branches, and trunks, and the height of the trees relative to the antenna heights will all be considered.

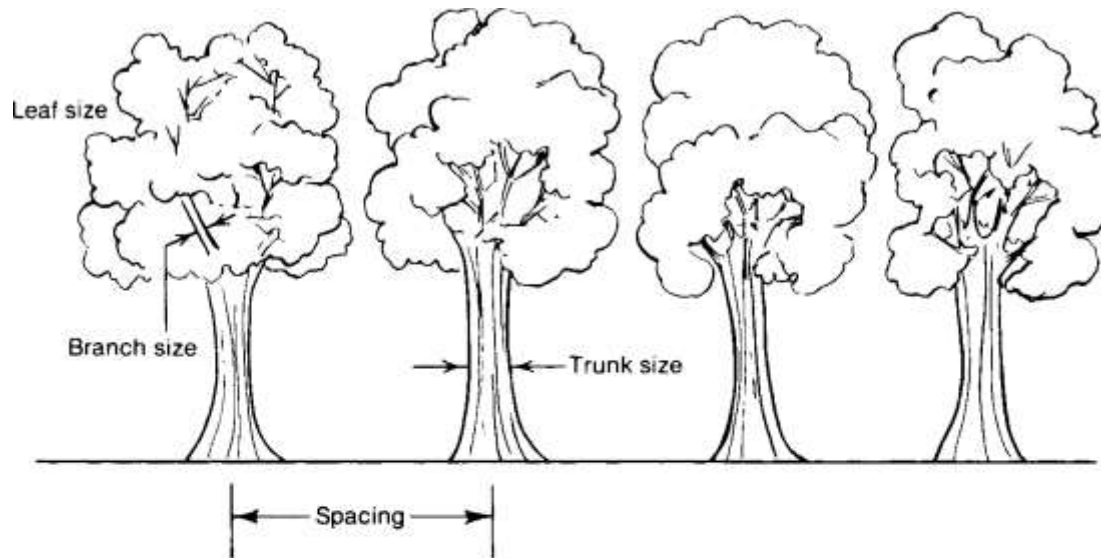

A characteristic of foliage environment.

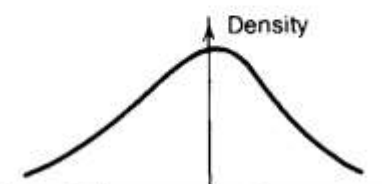

Distributions of leaves, trunks, or branches



Distribution of spacing between adjacent trunks or branches

This unique problem can become very complicated . For a system design, the estimate of the signal reception due to foliage loss does not need any degree of accuracy.

Furthermore, some trees, such as maple or oak, lose their leaves in winter, while others, such as pine, never do.

However, a rough estimate should be sufficient for the purpose of system design. In tropic zones, the sizes of tree leaves are so large and thick that the signal can hardly penetrate.

Sometime the foliage loss can be treated as a wire-line loss, in decibels per foot or decibels per meter, when the foliage is uniformly heavy and the path lengths are short.

When the path length is long and the foliage is non uniform, then decibels per octaves or decibels per decade is used.

PROPAGATION IN NEAR-IN DISTANCE

We are using the suburban area as an example.

At the 1-mi intercept, the received level is -61.7 dBm based on the reference set of parameters; that is, the antenna height is 30 m (100 ft).

If we increase the antenna height to 60 m (200 ft), a 6-dB gain is obtained. From 60 to 120 m (200 to 400-ft), another 6 dB is obtained.

At the 120-m (400-ft) antenna height, the mobile received signal is the same as that received at the free space.

The antenna pattern is not isotropic in the vertical plane.

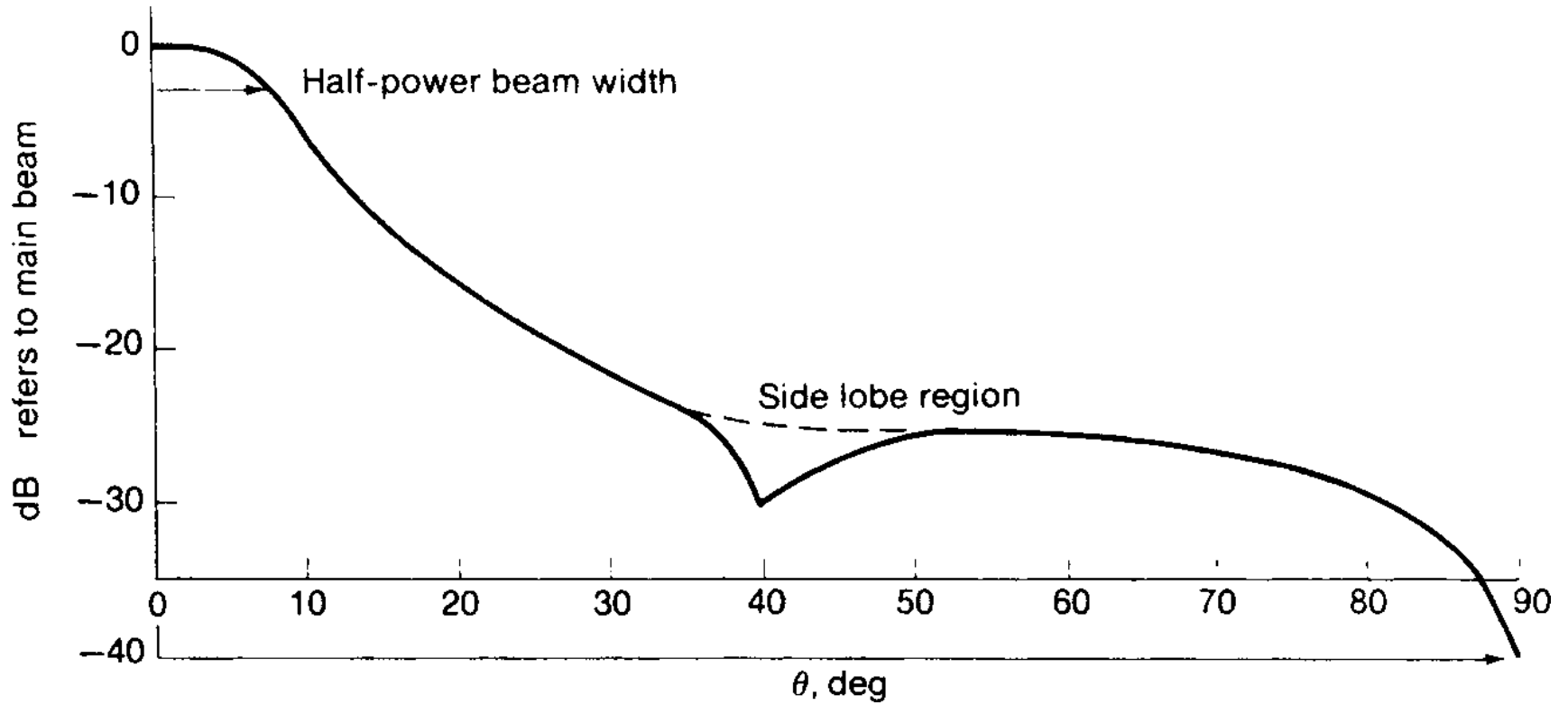

A typical 6-dB omni-directional antenna beam width.

The reduction in signal reception can be found in the figure and is listed in the table below.

At $d = 100 \text{ m}$ (328 ft) [mobile antenna height = 3 m (10 ft)], the incident angles and elevation angles are 11.77° and 10.72° , respectively.

Antenna Height h_1 , m (ft)	Incident Angle θ , Degrees	Elevation Angle ϕ , Degrees	Attenuation α , dB
90 (300)	30.4	29.6	21
60 (200)	21.61	20.75	16
30 (100)	11.77	10.72	6

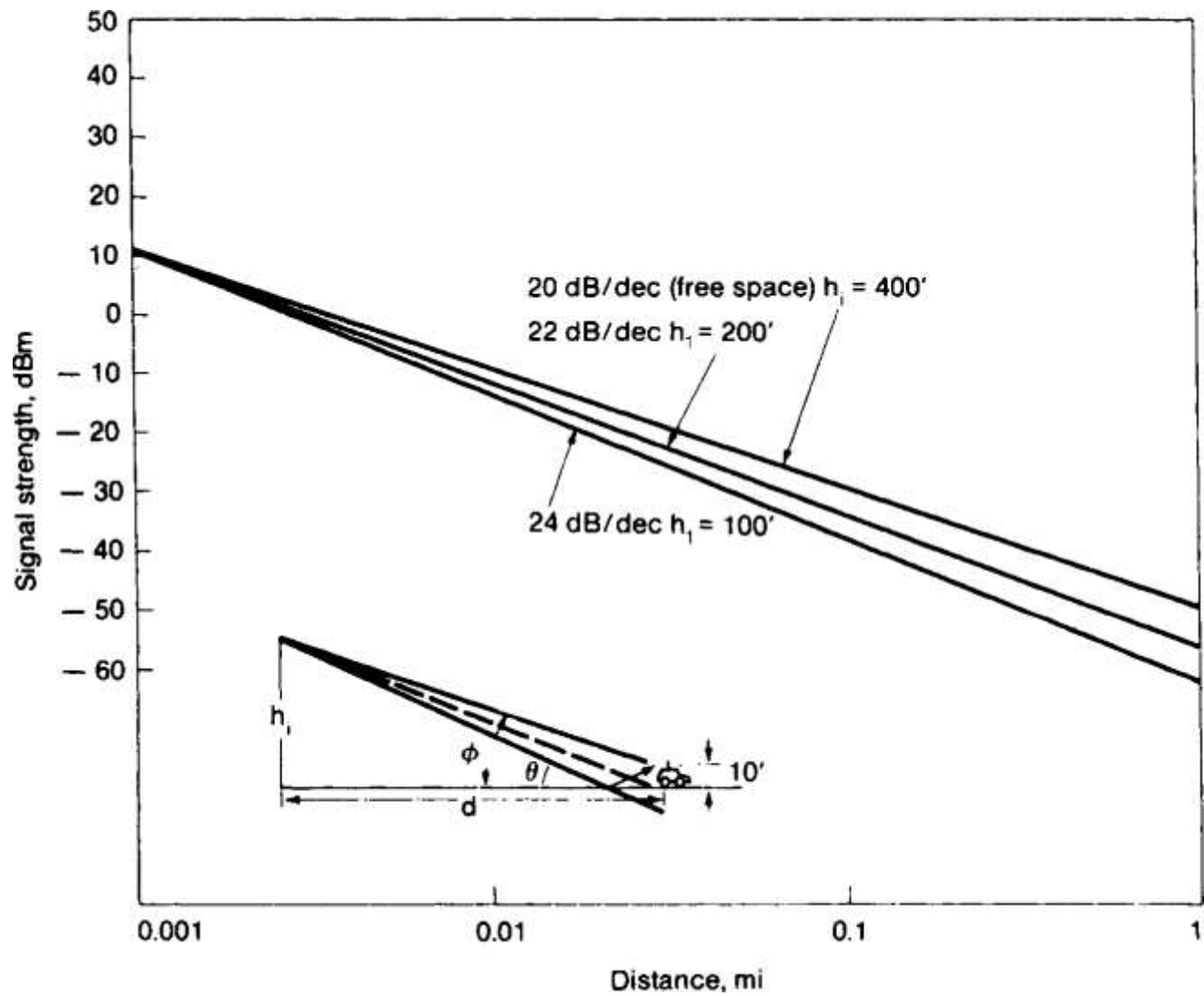

Curves for near-in propagation.

Calculation of Near-Field Propagation

The range d_F of near field can be obtained by letting φ in the equation below be π .

$$\Delta\phi = \frac{4\pi h_1 h_2}{\lambda d_F} = \pi$$

and then

$$d_F = \frac{4h_1 h_2}{\lambda}$$

The signal received within the near field ($d < d_F$) uses the free space loss formula, and the signal received outside the near field ($d > d_F$) can use the mobile radio path loss formula, for the best approximation.

LONG-DISTANCE PROPAGATION

The advantage of a high cell site is that it covers the signal in a large area, especially in a noise-limited system where usually different frequencies are repeatedly used in different areas.

However, we have to be aware of the long-distance propagation phenomenon.

A noise-limited system gradually becomes an interference-limited system as the traffic increases.

The interference is due to not only the existence of many co-channels and adjacent channels in the system, but the long-distance propagation also affects the interference.

Within an Area of 50-mi Radius

For a high site, the low-atmospheric phenomenon would cause the ground wave path to propagate in a non-straight-line fashion.

The wave path can bend either upward or downward.

Then we may have the experience that at one spot the signal may be strong at one time but weak at another.

At a Distance of 320 km (200 mi)

Troposphere wave propagation prevails at 800 MHz for long-distance propagation; sometimes the signal can reach 320 km (200 mi) away.

The wave is received 320 km away because of an abrupt change in the effective dielectric constant of the troposphere.

The dielectric constant changes with temperature, which decreases with height at a rate of about $6.5^{\circ}\text{C}/\text{km}$ and reaches -50°C at the upper boundary of the troposphere.

In tropospheric propagation, the wave may be divided by refraction and reflection.

Tropospheric refraction: This refraction is a gradual bending of the rays due to the changing effective dielectric constant of the atmosphere through which the wave is passing.

Tropospheric reflection: This reflection will occur where there are abrupt changes in the dielectric constant of the atmosphere. The distance of propagation is much greater than the line-of-sight propagation.

Moistness: Water content has much more effect than temperature on the dielectric constant of the atmosphere and on the manner in which the radio waves are affected.

The water vapor pressure decreases as the height increases.

Tropospheric wave propagation does cause interference and can only be reduced by umbrella antenna beam patterns, a directional antenna pattern, or a low-power low-antenna approach.

CELL SITE AND MOBILE ANTENNAS

ANTENNAS AT CELL SITE

- **For Coverage**
 - **Use Omni-directional Antennas**
 - *High-Gain Antennas*
- There are standard 6-dB and 9-dB gain Omni-directional antennas

Coverage High-gain Omni-directional antennas

Gain with reference to dipole: (a) 6 dB; (b) 9 dB

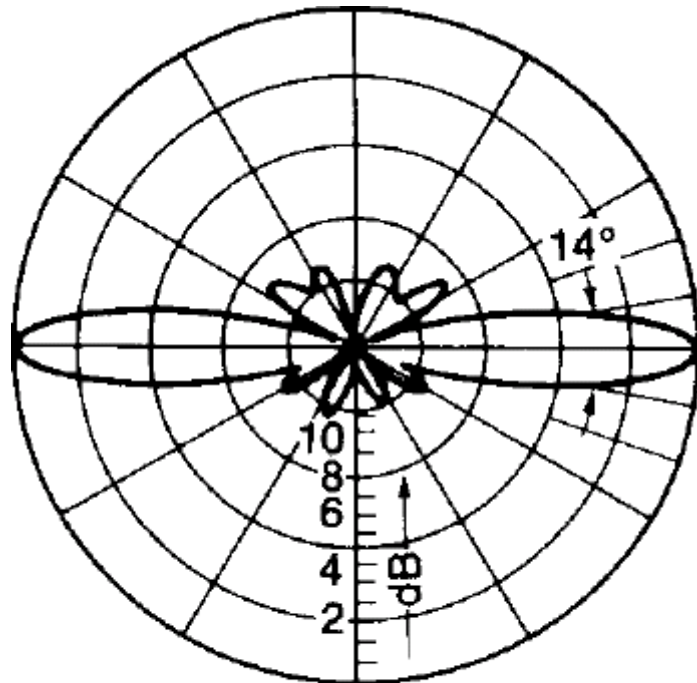

Vertical
(a)

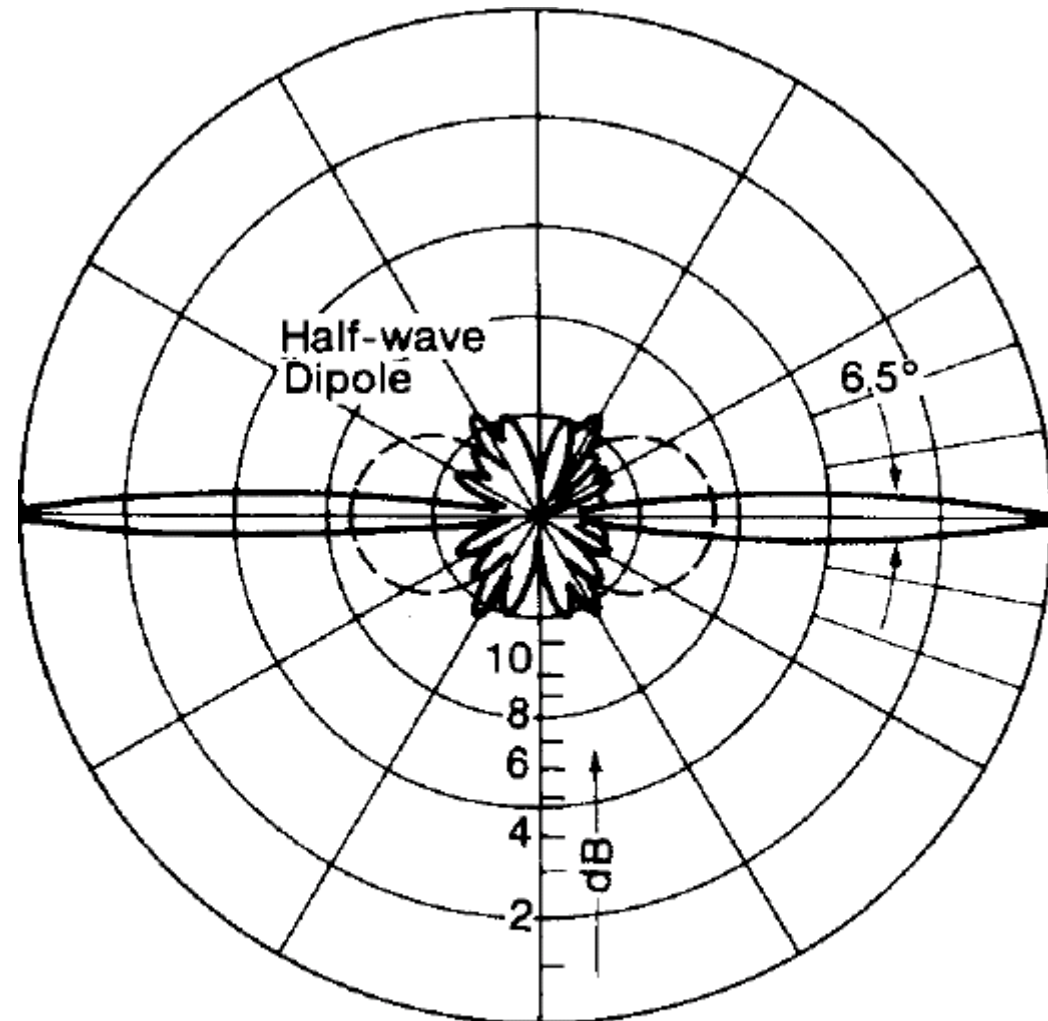

Vertical
(b)

Cell-site antennas for Omni cells

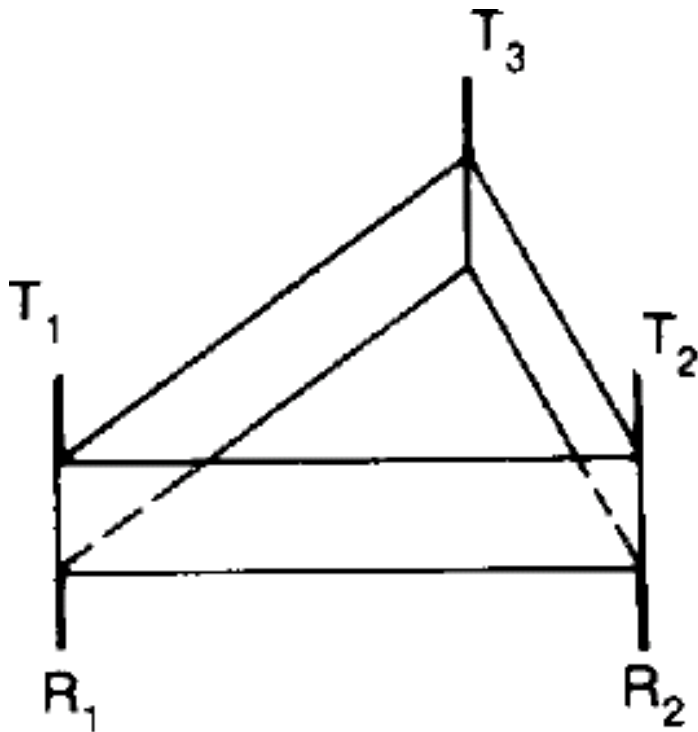

(a)

(a) for 3N channels

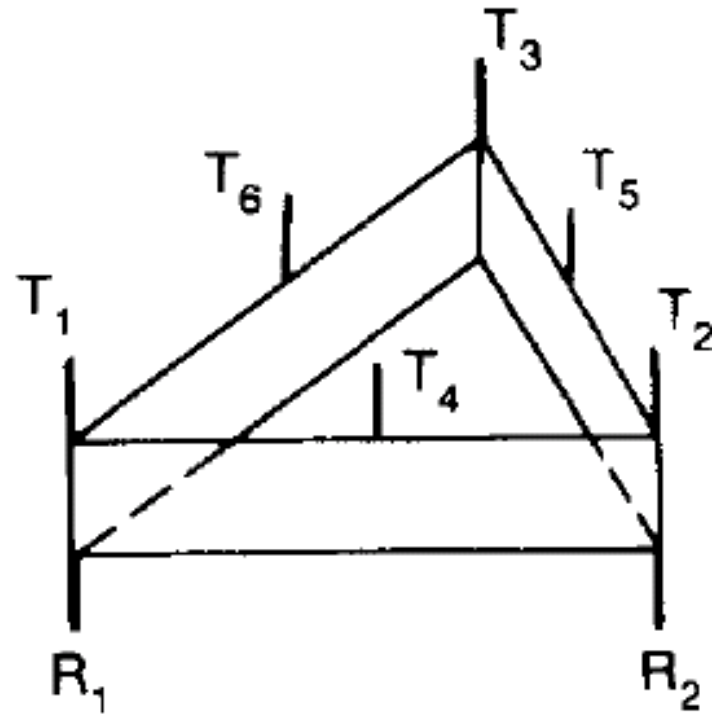

(b)

(b) for 6N channels.

Ring combiner

- A ring combiner is used to combine two groups of channels into a single output.
- The function of a ring combiner is to combine two 16-channel combiners into one 32-channel output.
- Therefore, all 32 channels can be used by a single transmitting antenna.
- The ring combiner has a limitation of handling power up to 600 W with a loss of 3 dB.

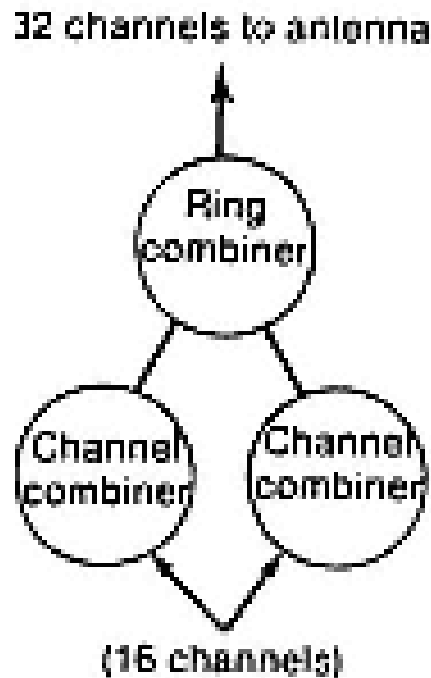

Relation between Gain and Beam Width

- **Relation between Gain and Beam Width**
- The receiver gain G_R can be related to its half-power beam width as

$$G_R = \frac{4\pi}{\theta_{HP}\phi_{HP}}$$

- θ_{HP} and ϕ_{HP} are the half-power beam widths in the θ and ϕ planes
- The factor 4π is the solid angle subtended by a sphere in steradians (square radians)

Relation between Gain and Beam Width

$$4\pi \text{ steradians} = 4\pi \times \left[\frac{180}{\pi} \right]^2 = 41,250 \text{ degree}^2 = \text{solid angle in a sphere}$$

$$G_R = \frac{41,250}{\theta_{HP}\phi_{HP}}$$

Directional antenna arrangement

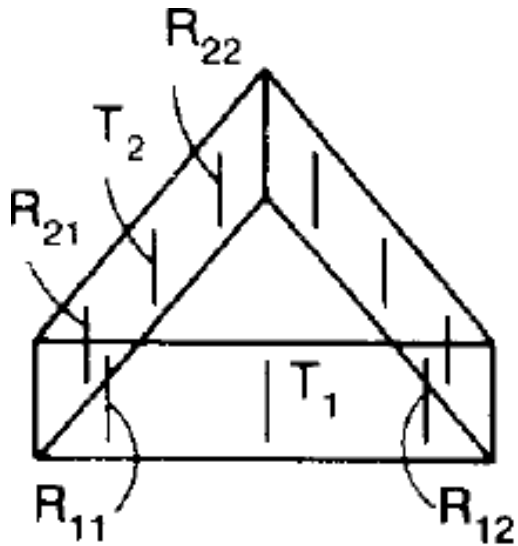

(a)

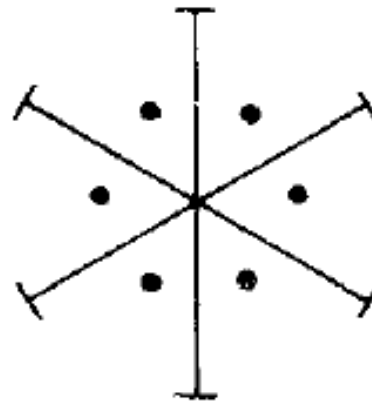

(b)

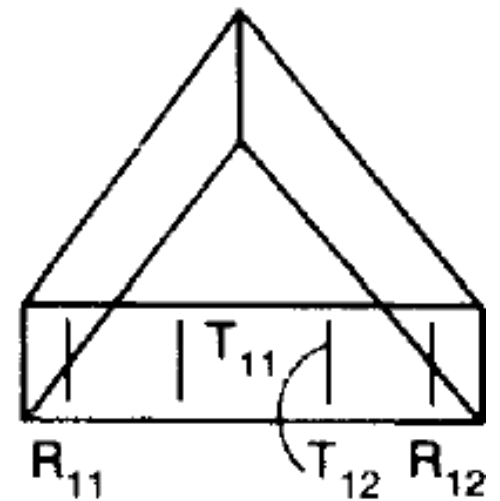

(c)

- (a) 120° sector (45 radios);**
- (b) 60° sector;**
- (c) 120° sector (90 radios).**

Cell-site antenna mounting

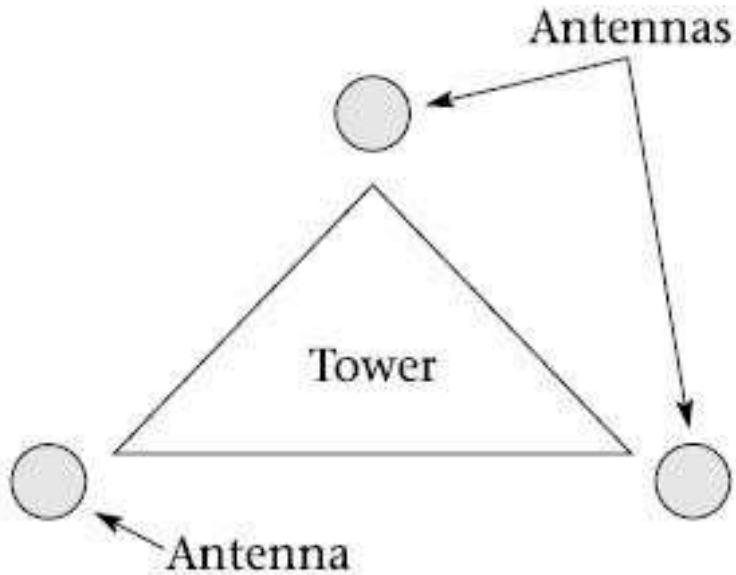

(a) Using omnidirectional antennas

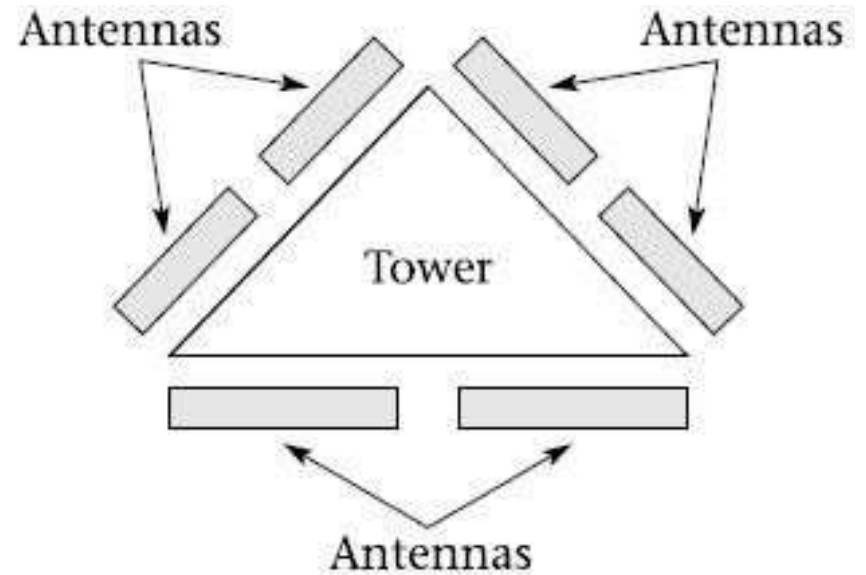

(b) Using directional antennas

Other Antennas at cell site

- Location antennas
- Setup channel antennas
- Spaced diversity antennas

Spatial Diversity

Receive antenna diversity

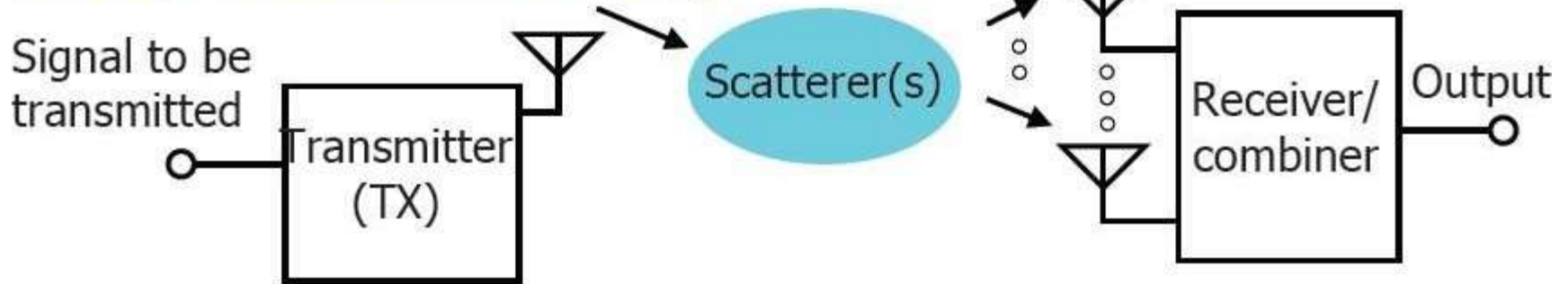

Diversity Antenna Spacing

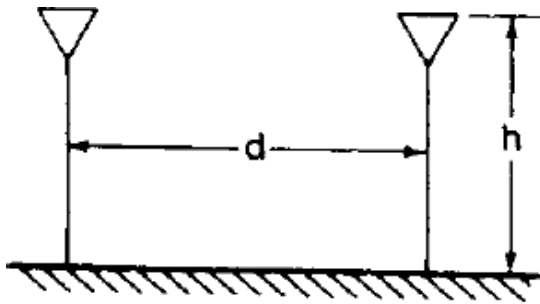

(a)

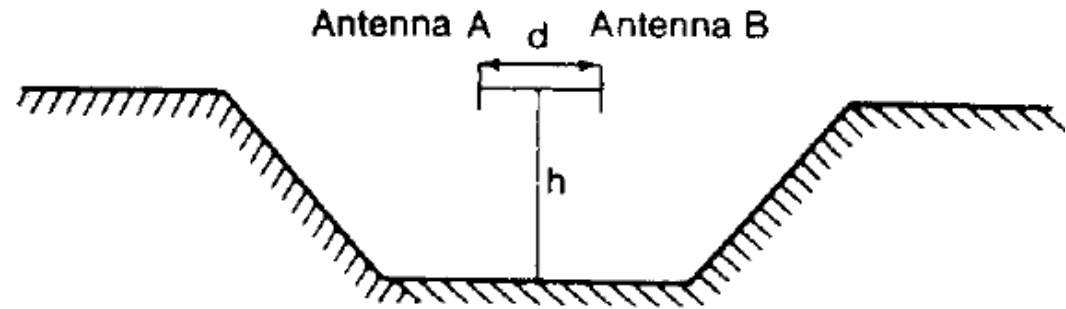

(b)

(a) $\eta = h/d$;

(b) proper arrangement with two antennas.

Umbrella-Pattern Antennas

- ***Normal Umbrella-Pattern Antenna.***
- ***Broadband Umbrella-Pattern Antenna***
- ***High-Gain Broadband Umbrella-Pattern Antenna***

Dipole antenna

$\lambda/2$ DIPOLE

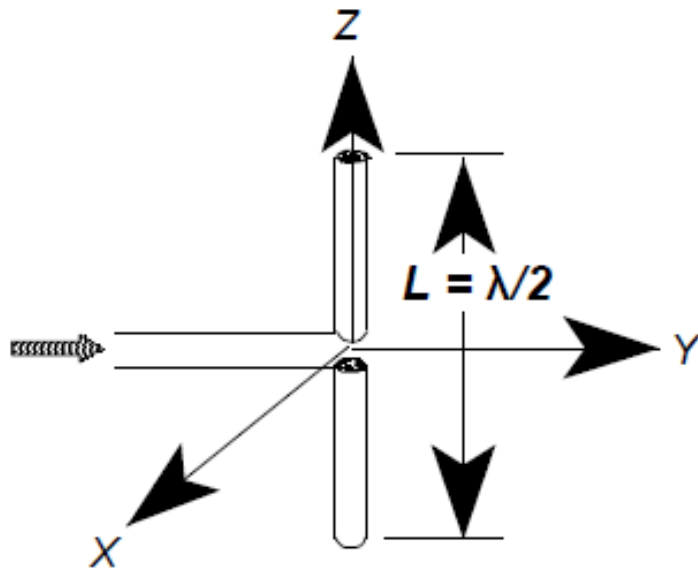

Elevation:

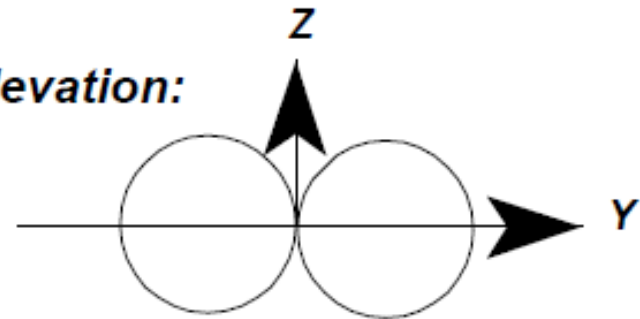

Azimuth:

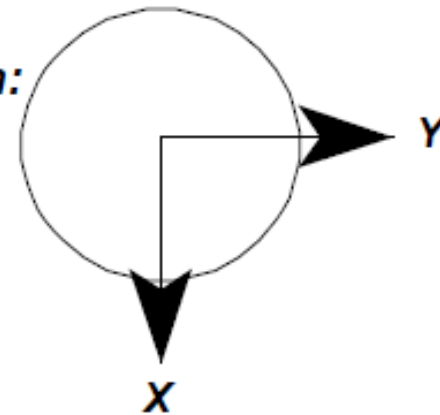

Monopole Antenna

MONOPOLE

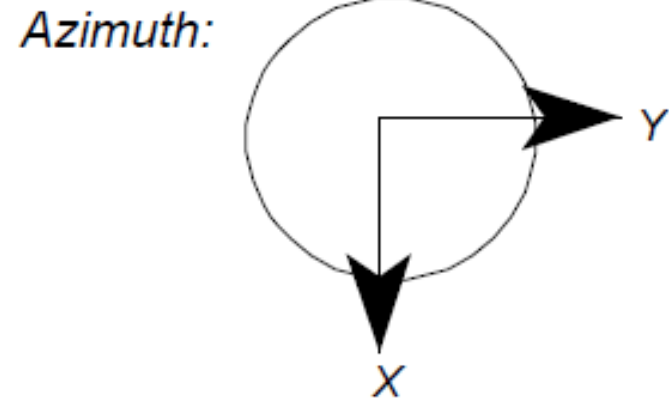
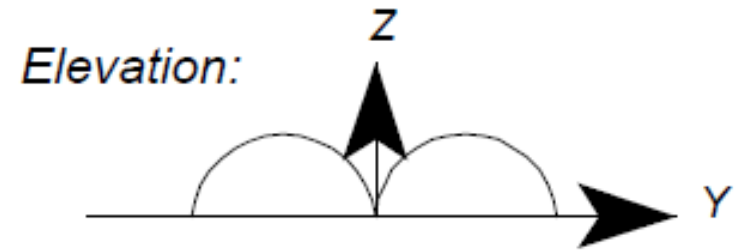
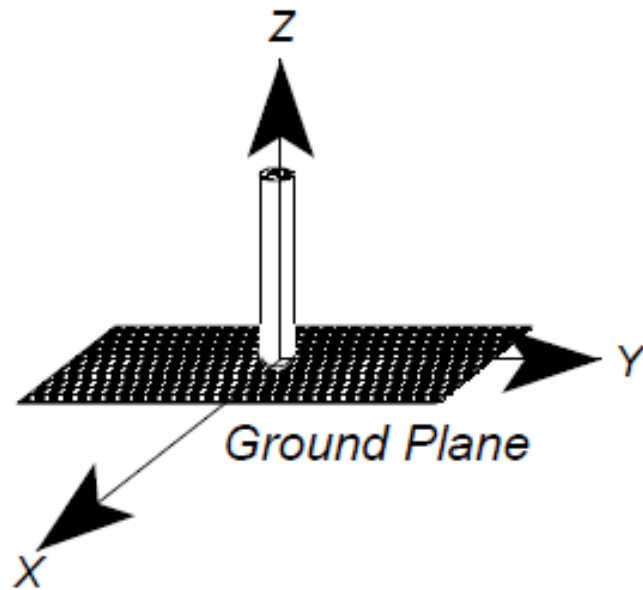

Discone Antennas

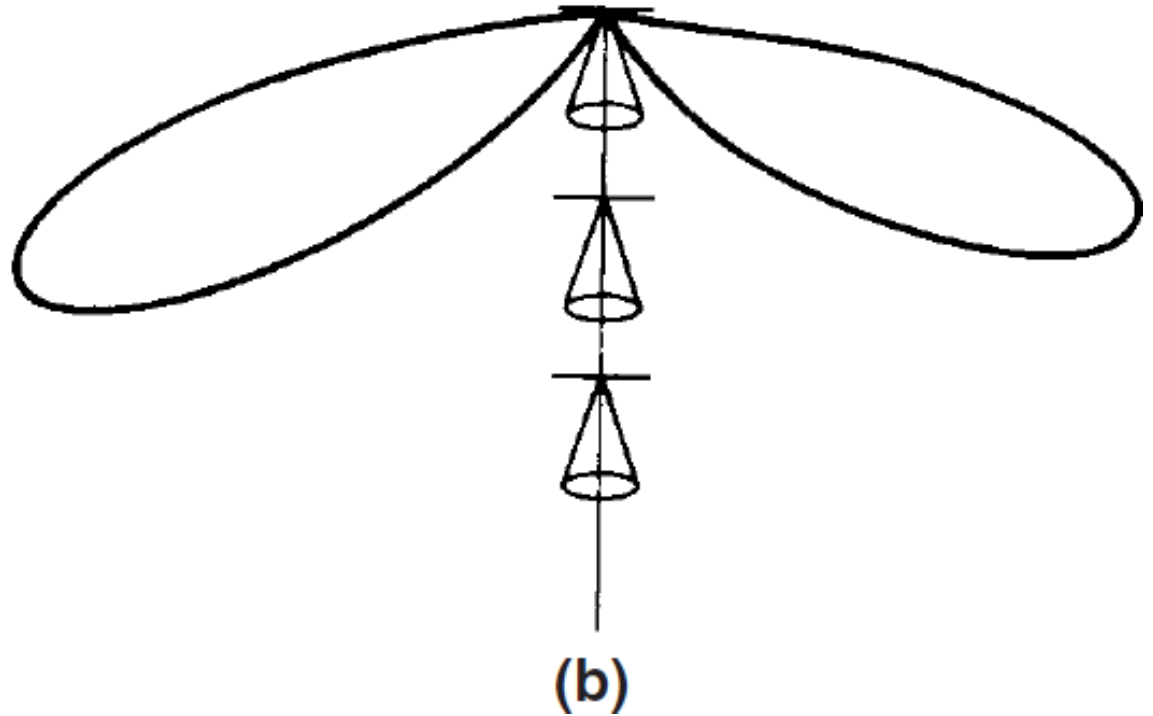
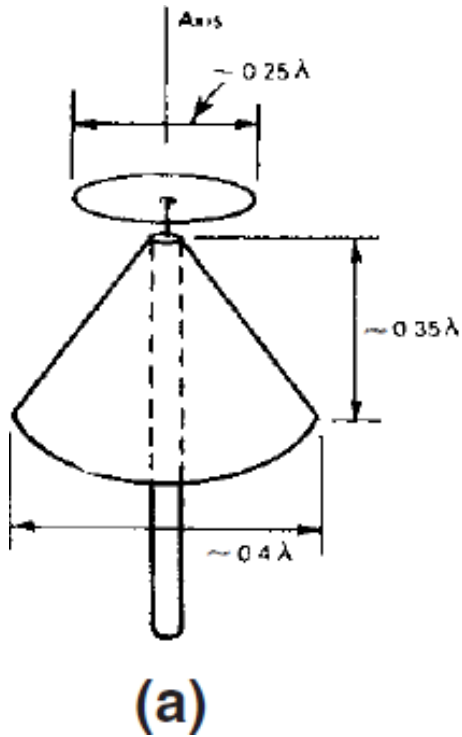

(a) Single antenna.

(b) An array of antennas

Photo of discone antenna



Discone Antenna

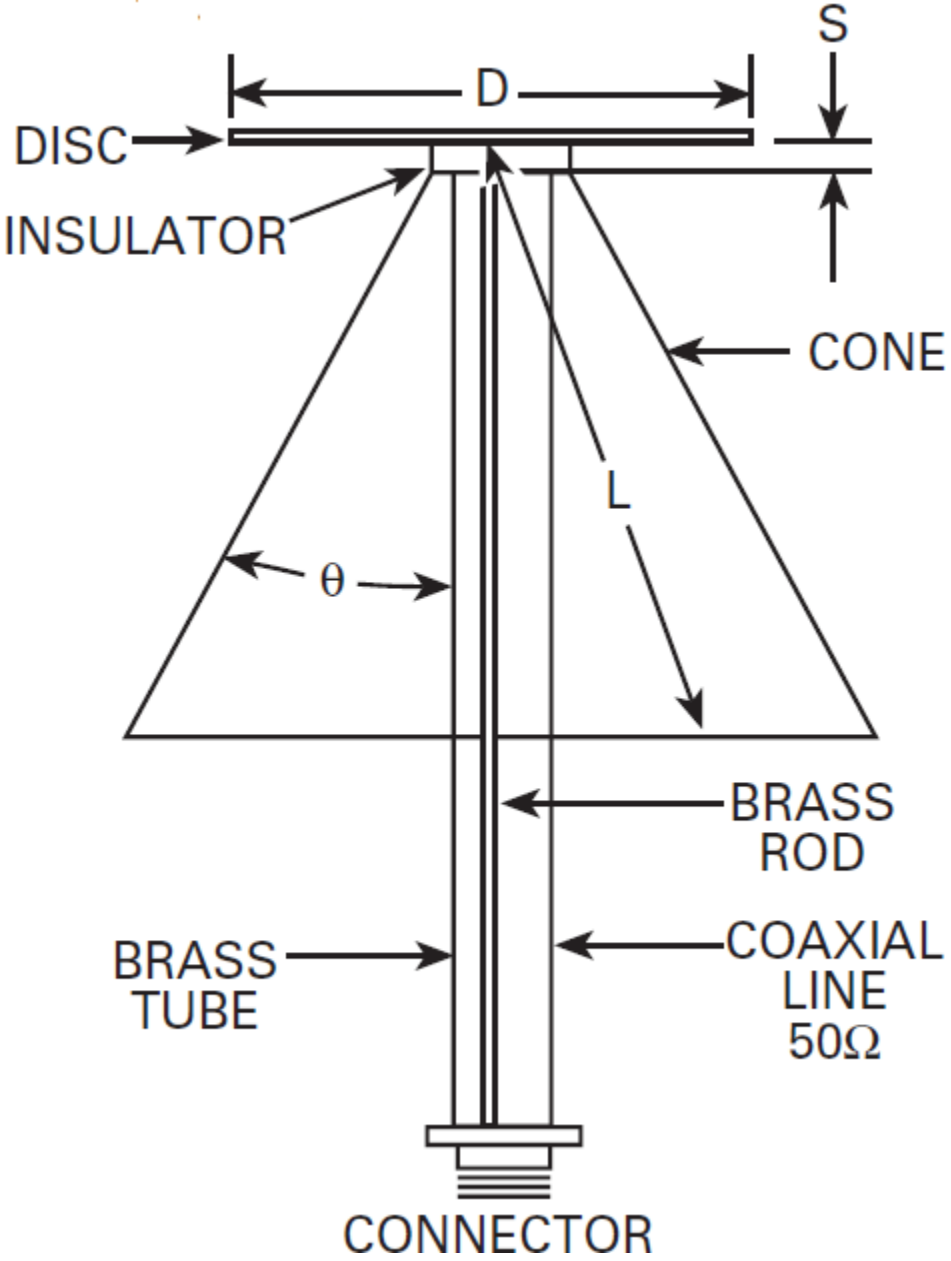

$$L = 2953 / F_{\text{MHz}}$$

$$D = 2008 / F_{\text{MHz}}$$

$$\theta = 25^\circ \text{ to } 40^\circ$$

S = 20% of coaxial line diameter or 0.125 inch

Where F = lowest frequency - 700 MHz selected, D = disc diameter, L = length of cone element, θ = angle of cone - selected value, S = spacing - selected value

Radiation pattern

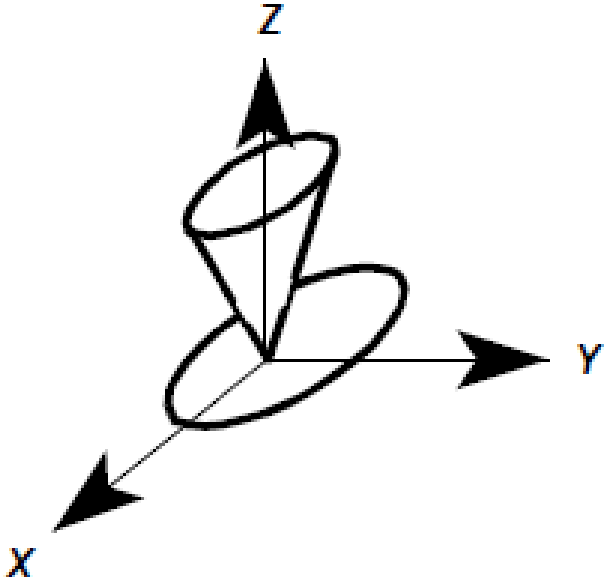
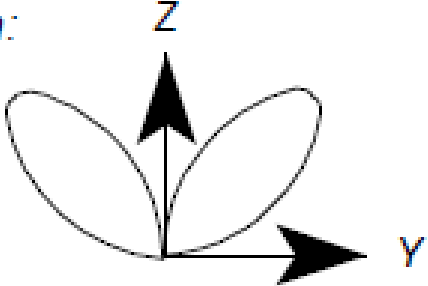
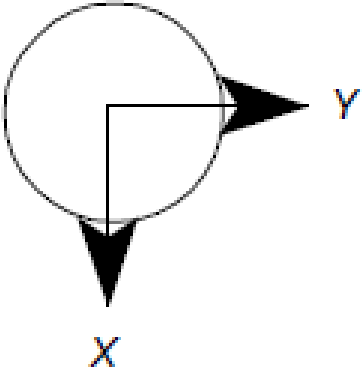
<i>Antenna Type</i>	<i>Radiation Pattern</i>
<p data-bbox="255 568 502 614"><i>DISCONE</i></p>  <p>A 3D diagram of a DISCONE antenna. It features a central vertical z-axis and a horizontal y-axis. The antenna structure consists of a circular disc at the base and a conical horn-like structure extending upwards along the z-axis. The x-axis is shown pointing downwards and to the left.</p>	<p data-bbox="1070 568 1278 606"><i>Elevation:</i></p>  <p data-bbox="1070 976 1259 1015"><i>Azimuth:</i></p>  <p>The radiation pattern is shown in two parts. The 'Elevation' view shows a vertical z-axis and a horizontal y-axis. The radiation pattern consists of two lobes, one pointing upwards and one pointing downwards, both centered on the z-axis. The 'Azimuth' view shows a circular pattern in the xy-plane. The radiation is uniform in all directions, forming a circle centered at the origin. The x-axis is vertical and the y-axis is horizontal.</p>

High gain Broadband umbrella-pattern antenna

$$E_0 = \frac{\sin[(Nd/2\lambda) \cos \phi]}{\sin[(d/2\lambda) \cos \phi]} \cdot (\text{individual umbrella pattern})$$

where ϕ = direction of wave travel

N = number of elements

d = spacing between two adjacent elements

UNIQUE SITUATIONS OF CELL-SITE ANTENNAS

Antenna Pattern in Free Space and in Mobile Environments

Front-to-back ratio of a directional antenna in a mobile radio environment.

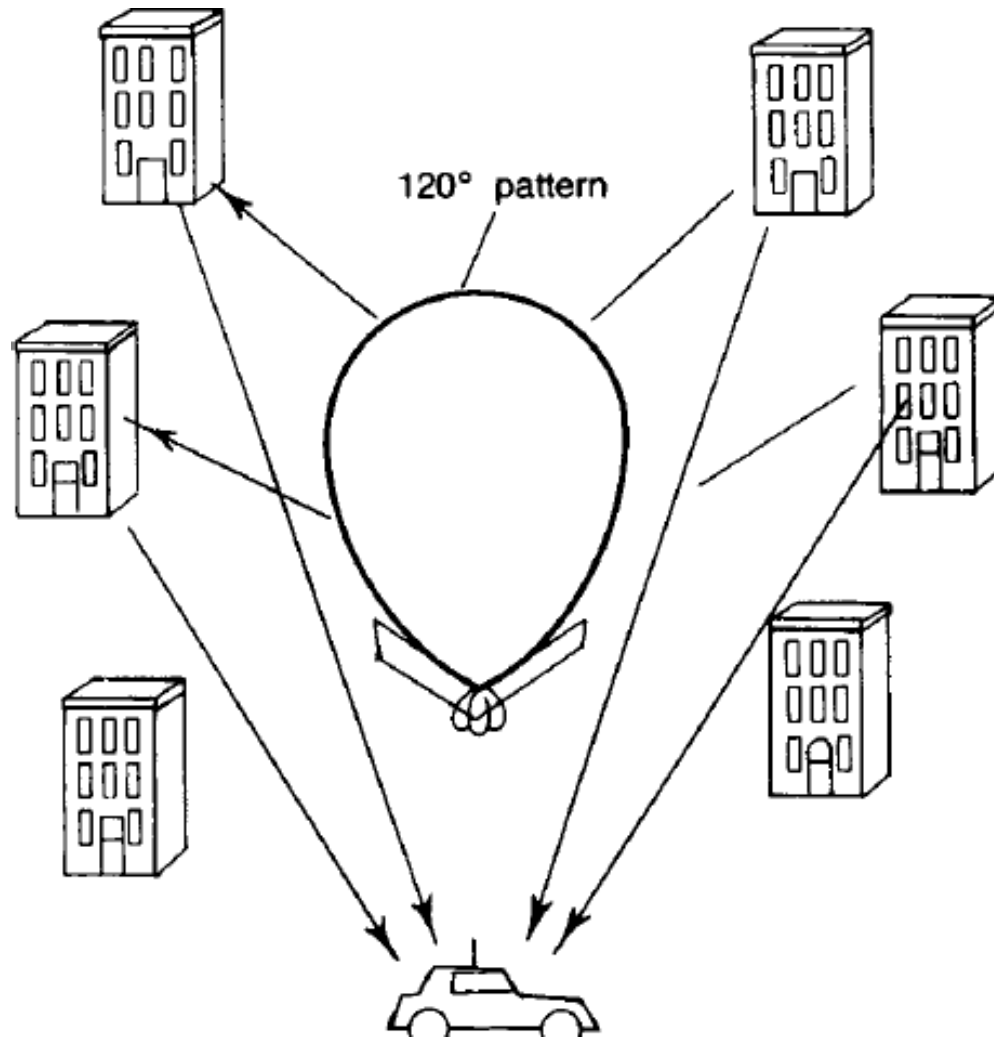

Minimum Separation of Cell-Site Receiving Antennas

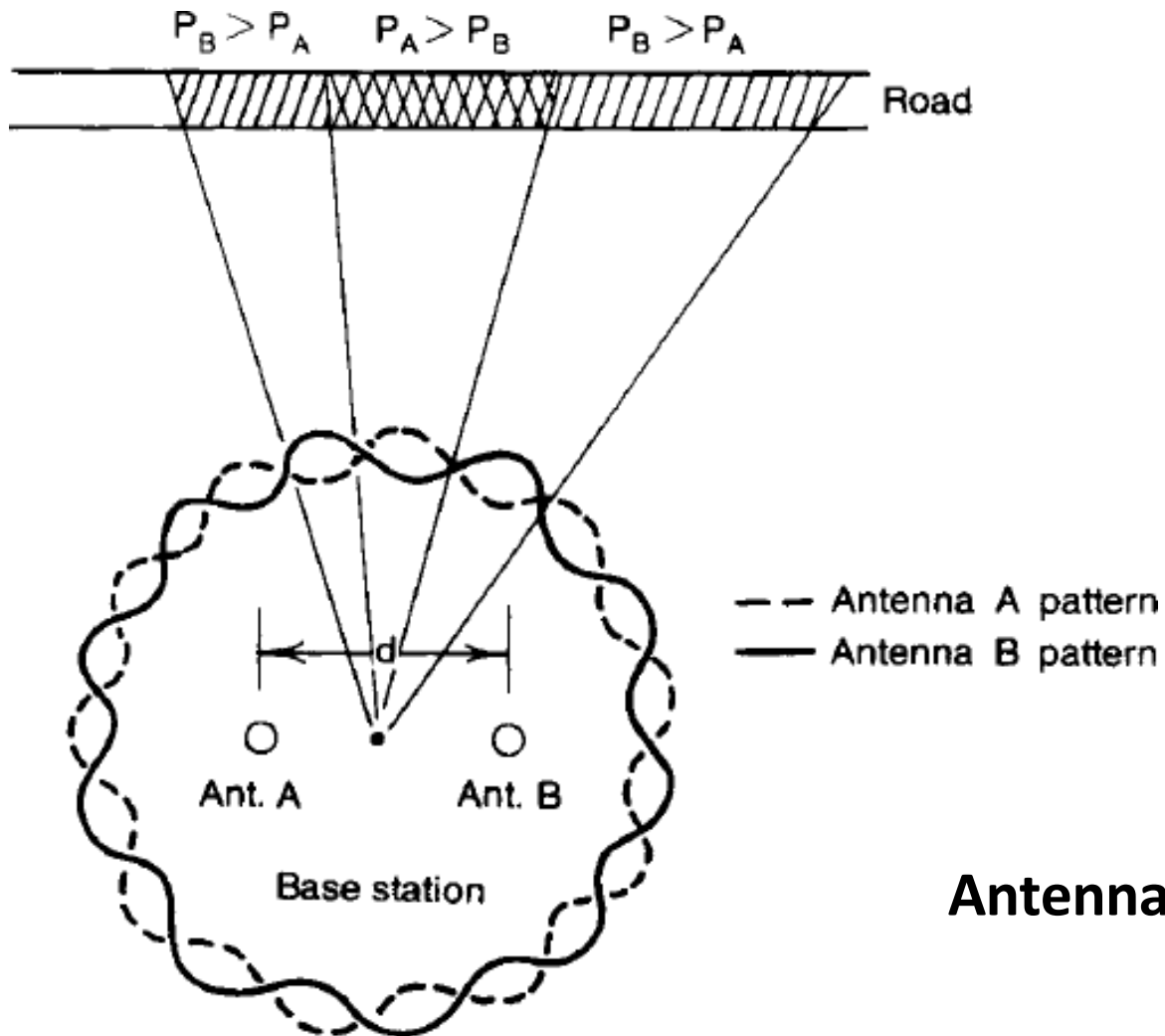

Antenna pattern ripple effect

- **Regular Check of the Cell-Site Antennas**
- **Choosing an Antenna Site**

MOBILE ANTENNAS

- **Roof-Mounted Antenna**
- **Glass-Mounted Antennas**

Mobile antenna patterns

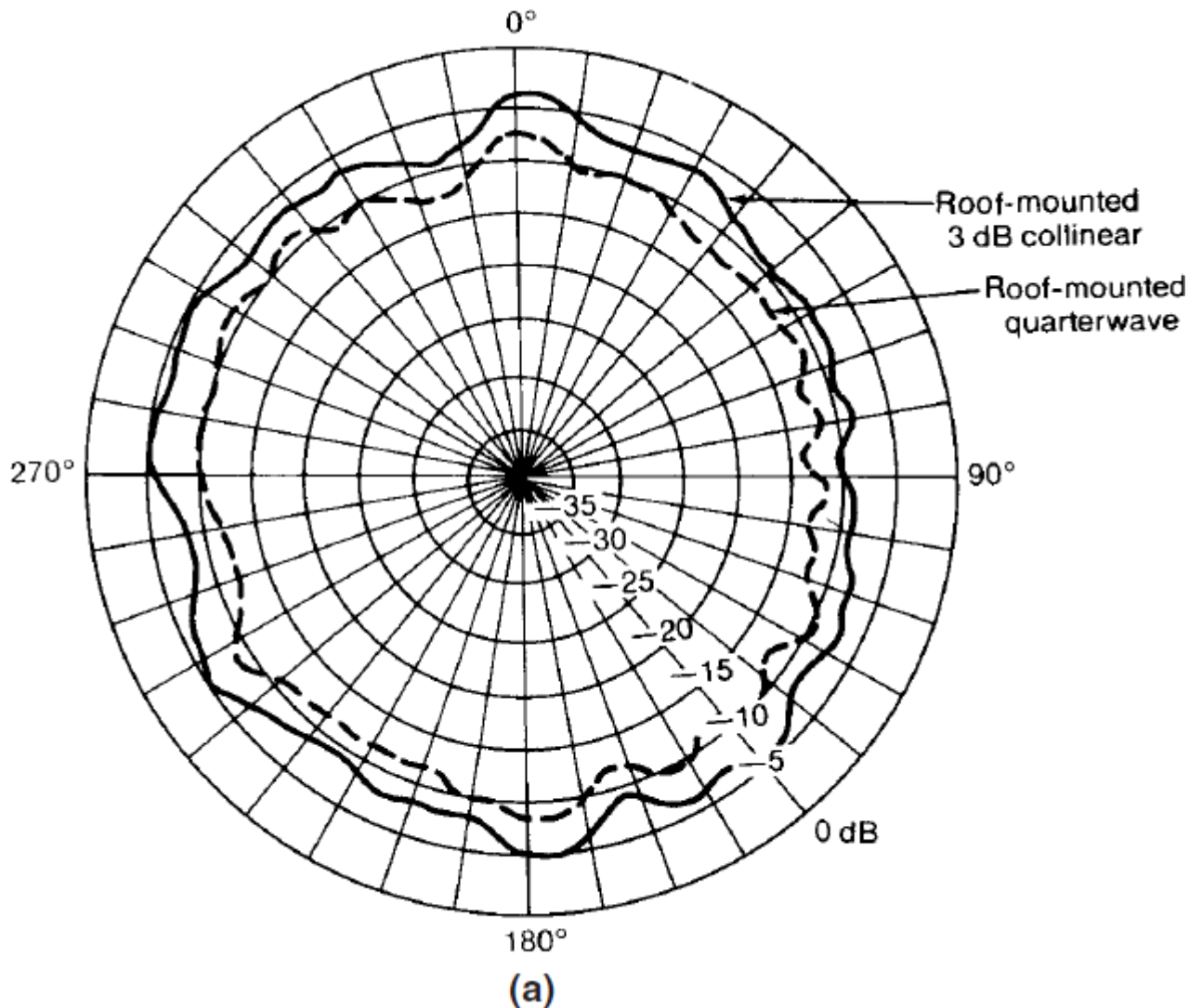

(a) Roof mounted 3-dB-gain collinear antenna versus roof-mounted quarter-wave antenna.

Mobile antenna patterns

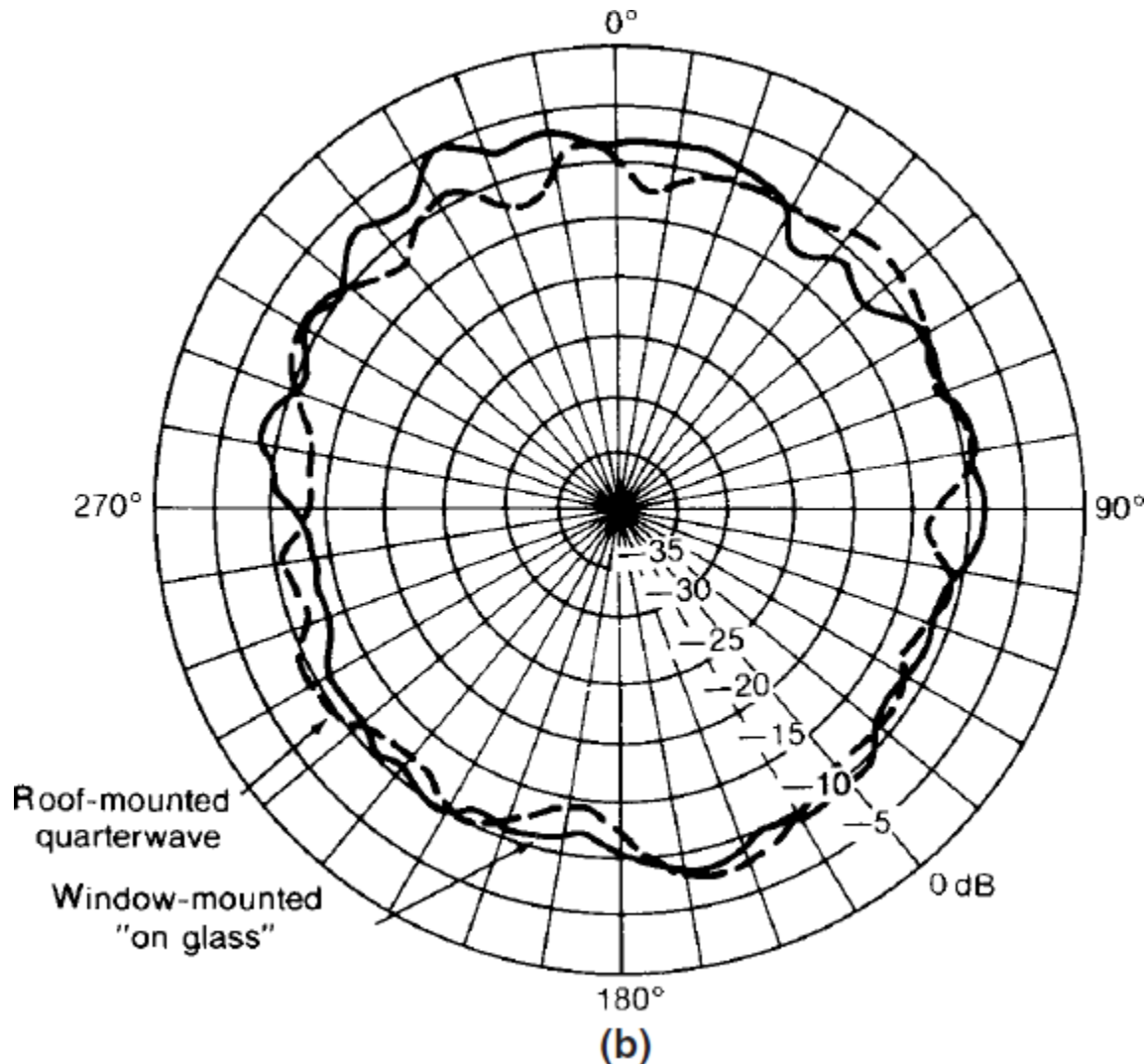

(b) Window mounted
"on-glass" gain
antenna versus roof-
mounted quarter-
wave antenna.

Roof Mounted Antenna

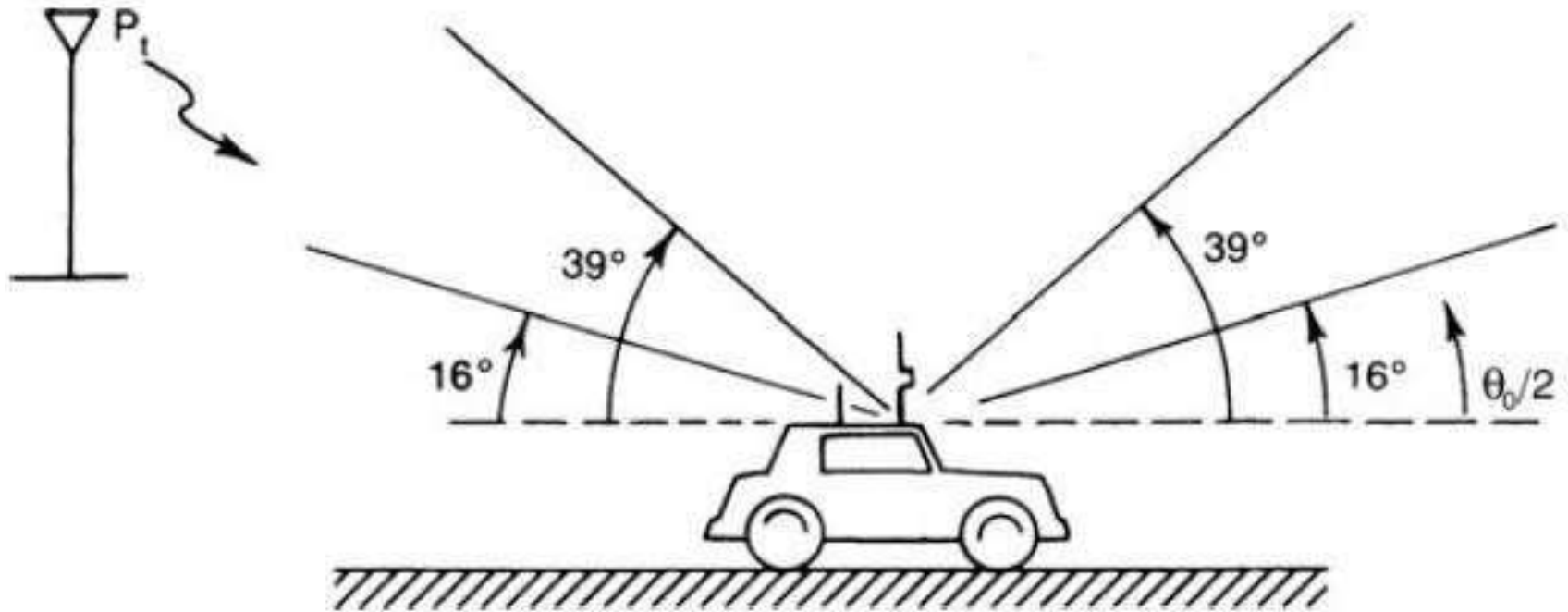
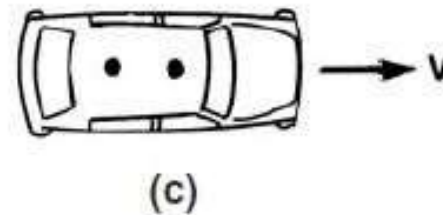
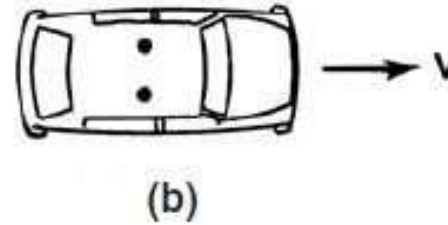
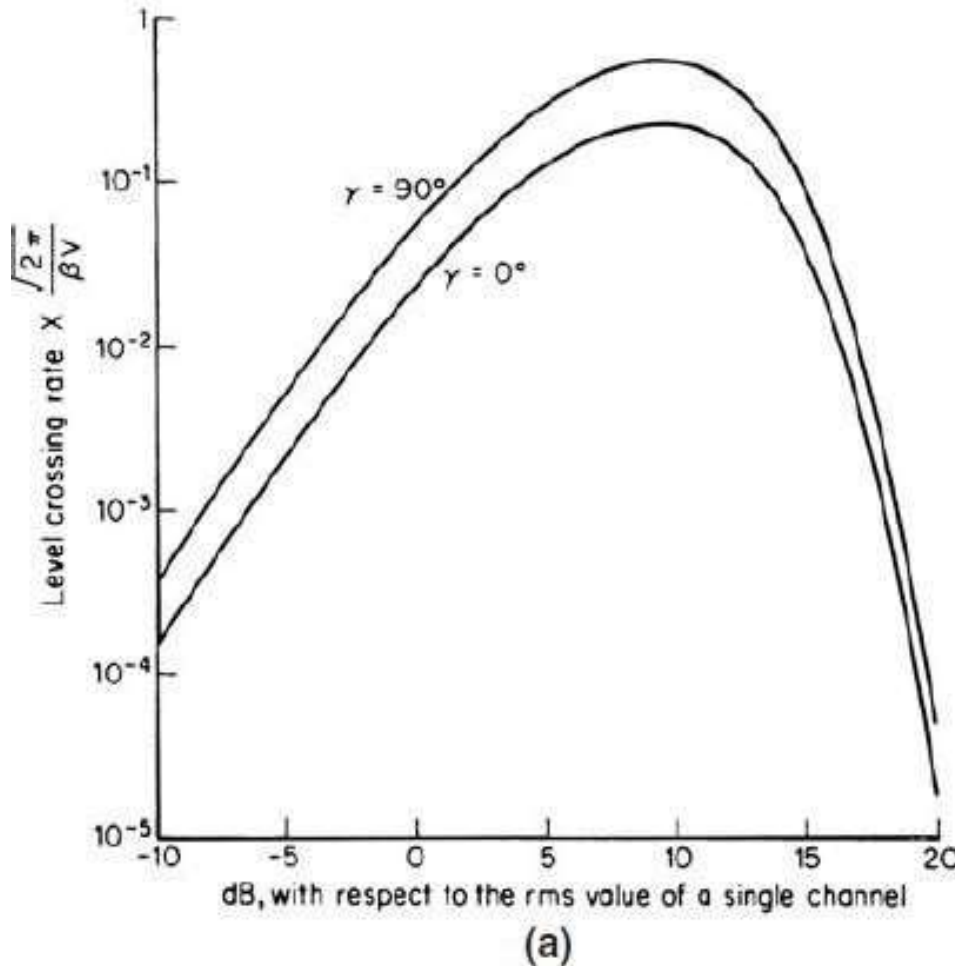

FIGURE 8.49 Vertical angle of signal arrival.

Mobile Antennas

- **Mobile High-Gain Antennas**
- **Horizontally Oriented Space-Diversity Antennas**
- **Vertically Oriented Space-Diversity Antennas**

Horizontally spaced antennas



(a) Maximum difference in lcr of a four-branch equal-gain signal between $\alpha = 0$ and $\alpha = 90^\circ$ with antenna spacing of 0.15λ
 (b) Not recommended. (c) Recommended.

Level Crossing Rate

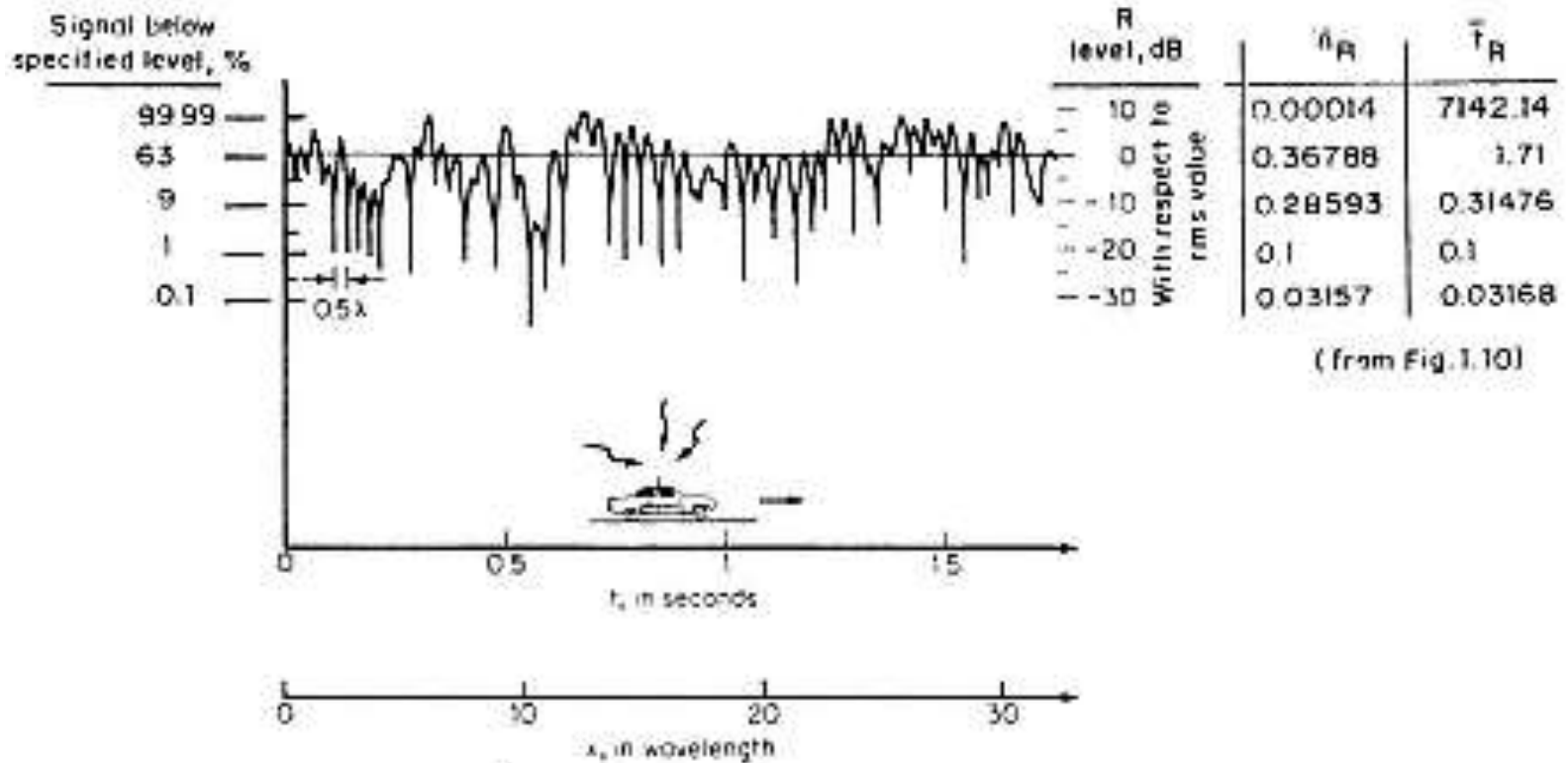

$$p(R) = R e^{-R^2} \quad \text{cumulative probability distribution}$$

$$\bar{n}(R) = \frac{\beta v}{\sqrt{2\pi}} \times n_R \quad \text{level crossing rate}$$

$$\bar{T}(R) = \frac{\sqrt{2\pi}}{\beta v} \times \bar{T}_R \quad \text{average duration of fades}$$

Vertical separation between two mobile antennas.

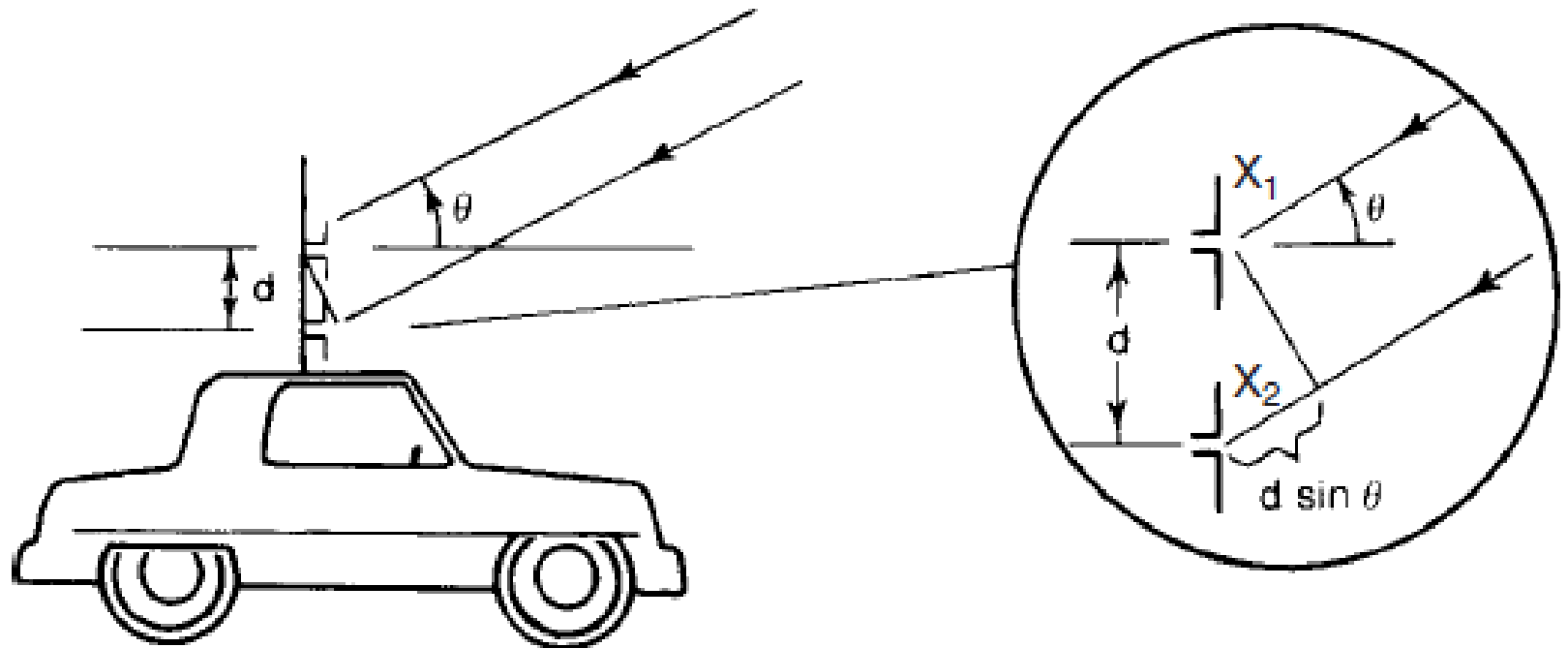

The theoretical derivation of correlation

$$\rho\left(\frac{d}{\lambda}, \theta\right) = \frac{\sin[(\pi d / \lambda) \sin \theta]}{(\pi d / \lambda) \sin \theta}$$

Correlation coefficients in different areas and different street orientations.

Area	Correlation Coefficient	
	Average	Standard Deviation
New York City	0.1	0.06
Suburban New Jersey		
Radial streets	0.226	0.127
Perpendicular streets	0.35	0.182

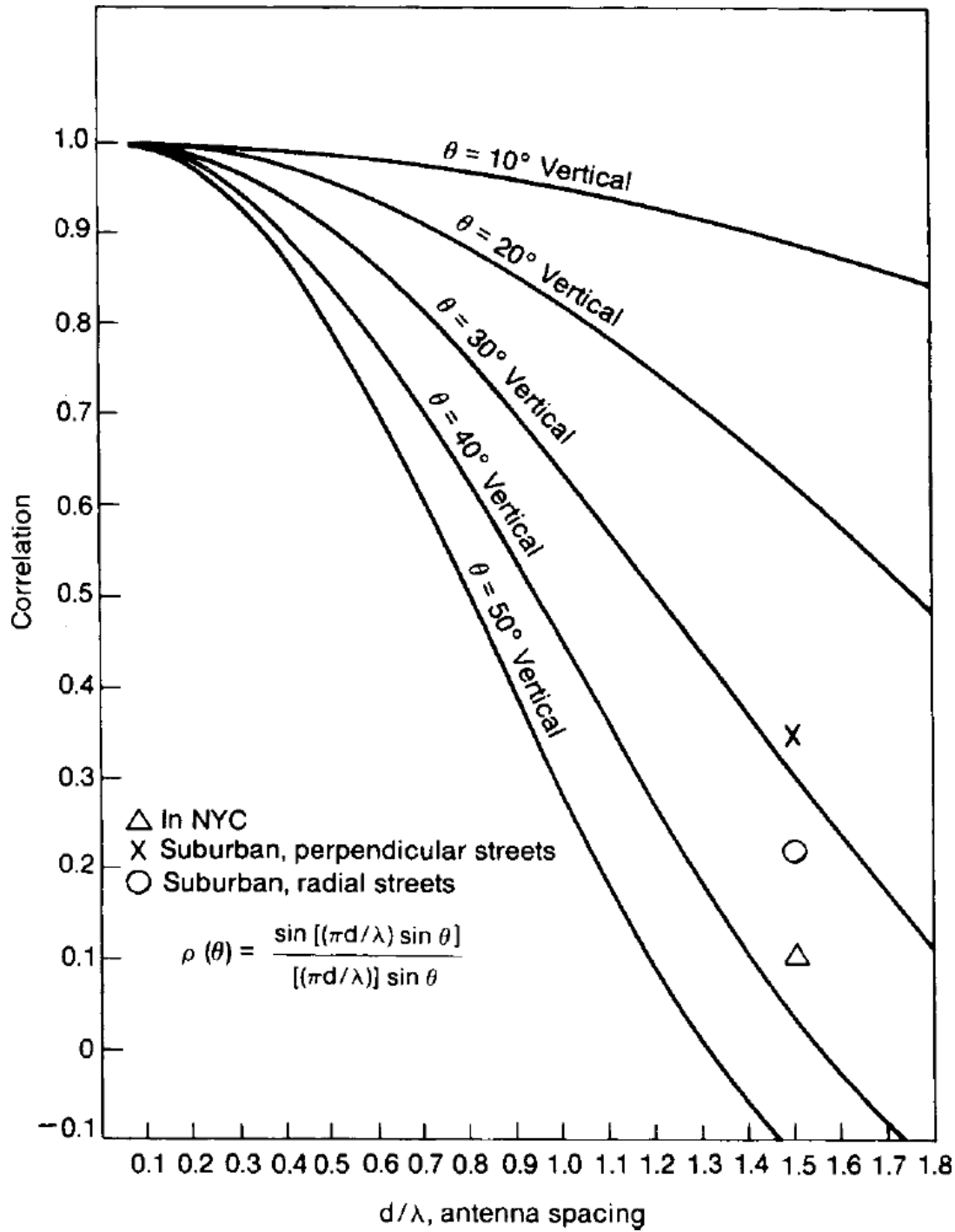

Two vertically spaced antennas mounted on a mobile unit.

UNIT-IV
FREQUENCY MANAGEMENT AND
CHANNEL ASSIGNMENT

Frequency Management

- ***Frequency management***
 - Designating set-up channels and voice channels (done by the FCC),
 - Numbering the channels (done by the FCC), and
 - Grouping the voice channels into subsets (done by each system according to its preference).

Channel assignment

- Means the allocation of specific channels to cell sites and mobile units.
- A fixed channel set – Cell site- **long-term basis**
- During a call- Mobile unit - **short-term basis** (handled by MTSO).

Channel Assignment

- Ideally channel assignment should be based on causing the least interference in the system.

Numbering the Channels

- The total number of channels (January 1988) is 832.
- But most mobile units and systems are still operating on 666 channels.
- A channel consists of two frequency channel bandwidths,
 - one in the low band
 - one in the high band

Numbering the Channels

- Two frequencies in channel 1 are
 - 825.030 MHz (mobile transmit) and
 - 870.030 MHz (cell-site transmit)
- The two frequencies in channel 666 are
 - 844.98 MHz (mobile transmit) and
 - 889.98 MHz (cell-site transmit)

Numbering the Channels

- The 666 channels are divided into two groups:
 - block A system
 - block B system

Frequency-management chart.

	1A	2A	3A	4A	5A	6A	7A	1B	2B	3B	4B	5B	6B	7B	1C	2C	3C	4C	5C	6C	7C
	1	2	3	4	5	6	7	8	9	10	11	12	13	14	15	16	17	18	19	20	21
	22	23	24	25	26	27	28	29	30	31	32	33	34	35	36	37	38	39	40	41	42
	43	44	45	46	47	48	49	50	51	52	53	54	55	56	57	58	59	60	61	62	63
	64	65	66	67	68	69	70	71	72	73	74	75	76	77	78	79	80	81	82	83	84
	85	86	87	88	89	90	91	92	93	94	95	96	97	98	99	100	101	102	103	104	105
	106	107	108	109	110	111	112	113	114	115	116	117	118	119	120	121	122	123	124	125	126
	127	128	129	130	131	132	133	134	135	136	137	138	139	140	141	142	143	144	145	146	147
	148	149	150	151	152	153	154	155	156	157	158	159	160	161	162	163	164	165	166	167	168
	169	170	171	172	173	174	175	176	177	178	179	180	181	182	183	184	185	186	187	188	189
	190	191	192	193	194	195	196	197	198	199	200	201	202	203	204	205	206	207	208	209	210
	211	212	213	214	215	216	217	218	219	220	221	222	223	224	225	226	227	228	229	230	231
	232	233	234	235	236	237	238	239	240	241	242	243	244	245	246	247	248	249	250	251	252
Block A system	253	254	255	256	257	258	259	260	261	262	263	264	265	266	267	268	269	270	271	272	273
	274	275	276	277	278	279	280	281	282	283	284	285	286	287	288	289	290	291	292	293	294
	295	296	297	298	299	300	301	302	303	304	305	306	307	308	309	310	311	312	—	—	—
	313	314	315	316	317	318	319	320	321	322	323	324	325	326	327	328	329	330	331	332	333
	334	335	336	337	338	339	340	341	342	343	344	345	346	347	348	349	350	351	352	353	354
355	356	357	358	359	360	361	362	363	364	365	366	367	368	369	370	371	372	373	374	375	
376	377	378	379	380	381	382	383	384	385	386	387	388	389	390	391	392	393	394	395	396	
397	398	399	400	401	402	403	404	405	406	407	408	409	410	411	412	413	414	415	416	417	
418	419	420	421	422	423	424	425	426	427	428	429	430	431	432	433	434	435	436	437	438	
439	440	441	442	443	444	445	446	447	448	449	450	451	452	453	454	455	456	457	458	459	
460	461	462	463	464	465	466	467	468	469	470	471	472	473	474	475	476	477	478	479	480	
481	482	483	484	485	486	487	488	489	490	491	492	493	494	495	496	497	498	499	500	501	
502	503	504	505	506	507	508	509	510	511	512	513	514	515	516	517	518	519	520	521	522	
523	524	525	526	527	528	529	530	531	532	533	534	535	536	537	538	539	540	541	542	543	
544	545	546	547	548	549	550	551	552	553	554	555	556	557	558	559	560	561	562	563	564	
565	566	567	568	569	570	571	572	573	574	575	576	577	578	579	580	581	582	583	584	585	
586	587	588	589	590	591	592	593	594	595	596	597	598	599	600	601	602	603	604	605	606	
607	608	609	610	611	612	613	614	615	616	617	618	619	620	621	622	623	624	625	626	627	
628	629	630	631	632	633	634	635	636	637	638	639	640	641	642	643	644	645	646	647	648	
649	650	651	652	653	654	655	656	657	658	659	660	661	662	663	664	665	666	—	—	—	

Control
channel
sets

Numbering the Channels

- Each block has 333 channels
- The 42 set-up channels are assigned as follows.
 - Channels 313 - 333 block A
 - Channels 334 - 354 block B
- The voice channels are assigned as follows.
 - Channels 1 - 312 (312 voice channels) block A
 - Channels 355 - 666 (312 voice channels) block B

Numbering the Channels- additional spectrum allocation

- New additional spectrum allocation - 10 MHz - additional 166 channels are assigned
- a 1 MHz is assigned below 825 MHz (or 870 MHz)
- additional channels will be numbered up to 849 MHz (or 894 MHz) and will then circle back
- The last channel number is 1023 ($=2^{10}$)
- There are no channels between channels 799 and 991.

New additional spectrum allocation

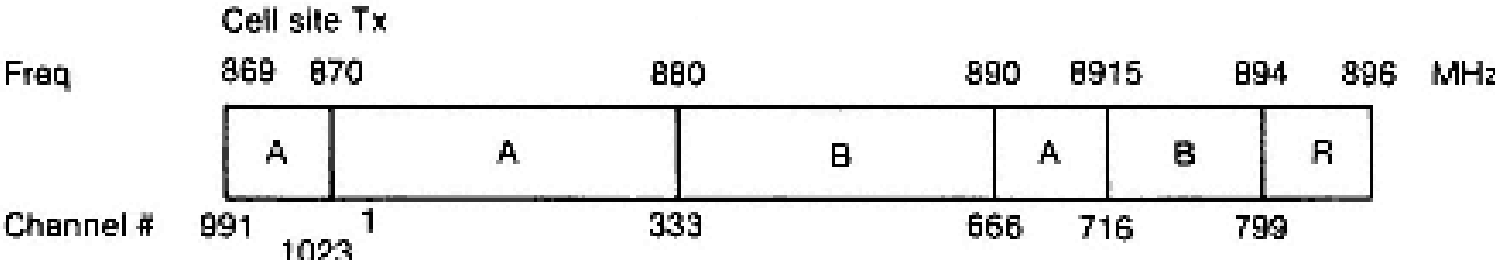
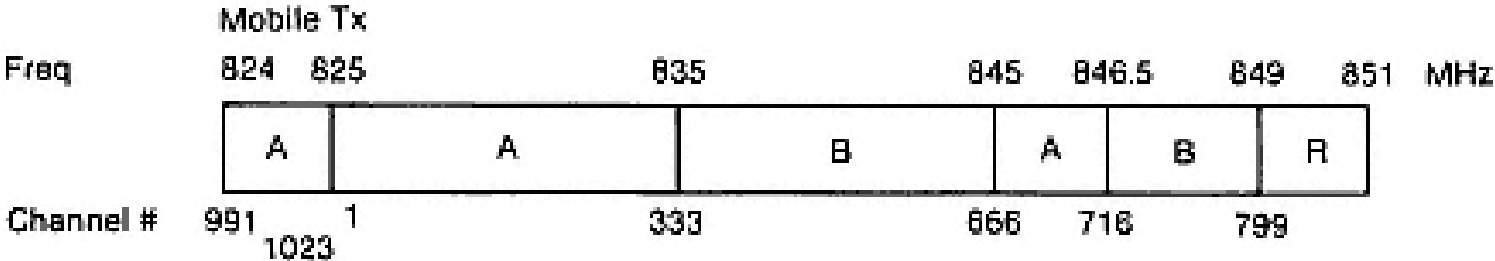

Full Spectrum Frequency Management

Block A																				
1A	2A	3A	4A	5A	6A	7A	1B	2B	3B	4B	5B	6B	7B	1C	2C	3C	4C	5C	6C	7C
1	2	3	4	5	6	7	8	9	10	11	12	13	14	15	16	17	18	19	20	21
22	23	24	25	26	27	28	29	30	31	32	33	34	35	36	37	38	39	40	41	42
43	44	45	46	47	48	49	50	51	52	53	54	55	56	57	58	59	60	61	62	63
64	65	66	67	68	69	70	71	72	73	74	75	76	77	78	79	80	81	82	83	84
85	86	87	88	89	90												102	103	104	105
106	107	108	109	110	111												123	124	125	126
127	128	129	130	131	132												144	145	146	147
148	149	150	151	152	153												165	166	167	168
169	170	171	172	173	174												186	187	199	190
190	191	192	193	194	195												207	208	209	210
211	212	213	214	215	216												228	229	230	231
232	233	234	235	236	237												249	250	251	252
253	254	255	256	257	258												270	271	272	273
274	275	276	277	278	279												291	292	293	294
295	296	297	298	299	300												312	X	X	X
313*	314	315	316	317	318	319	320	321	322	323	324	325	326	327	328	329	330	331	332	333
667	668	669	670	671	672	673	674	675	676	677	678	679	680	681	682	683	684	685	686	687
688	689	690	691	692	693	694	695	696	697	698	699	700	701	702	703	704	705	706	707	708
709	710	711	712	713	714	715	716	X	991	992	993	994	995	996	997	998	999	1000	1001	1002
1003	1004	1005	1006	1007	1008	1009	1010	1011	1012	1013	1014	1015	1016	1017	1018	1019	1020	1021	1022	1023

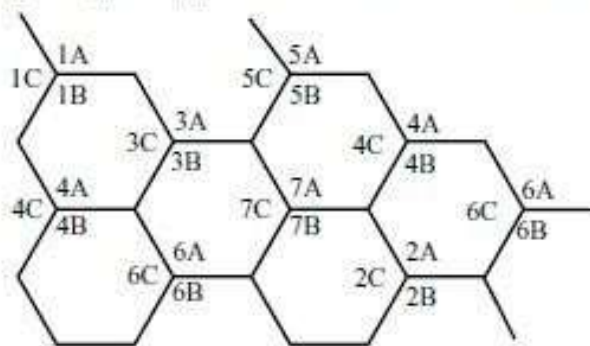

Full Spectrum Frequency Management

Block B

1A	2A	3A	4A	5A	6A	7A	1B	2B	3B	4B	5B	6B	7B	1C	2C	3C	4C	5C	6C	7C
334	335	336	337	338	339	340	341	342	343	344	345	346	347	348	349	350	351	352	353	354
355	356	357	358	359	360	361														375
376	377	378	379	380	381	382														396
397	398	399	400	401	402	403														417
418	419	420	421	422	423	424														438
439	440	441	442	443	444	445														459
460	461	462	463	464	465	466														480
481	482	483	484	485	486	487														501
502	503	504	505	506	507	508														522
523	524	525	526	527	528	529														543
544	545	546	547	548	549	550														564
565	566	567	568	569	570	571														585
586	587	588	589	590	591	592	593	594	595	596	597	598	599	600	601	602	603	604	605	606
607	608	609	610	611	612	613	614	615	616	617	618	619	620	621	622	623	624	625	626	627
628	629	630	631	632	633	634	635	636	637	638	639	640	641	642	643	644	645	646	647	648
649	650	651	652	653	654	655	656	657	658	659	660	661	662	663	664	665	666	717	718	719
720	721	722	723	724	725	726	727	728	729	730	731	732	733	734	735	736	737	738	739	740
741	742	743	744	745	746	747	748	749	750	751	752	753	754	755	756	757	758	759	760	761
762	763	764	765	766	767	768	769	770	771	772	773	774	775	776	777	778	779	780	781	782
783	784	785	786	787	788	789	790	791	792	793	794	795	796	797	798	799				

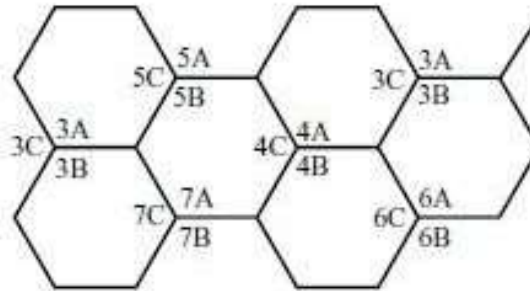

Grouping into Subsets

- **Voice channels** for each system is **312**
- We can group these into any number of **subsets 21 set-up channels** for each system
- it is logical to group the 312 channels into **21 subsets**
- **Each subset** then consists of **16 channels**
- In each set, the **closest adjacent** is **21 channel channels away**

Grouping into Subsets

- The 16 channels in each subset - connected to a channel combiner
- Wide separation between adjacent channels - requirement of minimum isolation
- Each 16-channel subset is idealized for each 16-channel combiner

Grouping into Subsets

- In a **seven-cell** pattern system each cell contains **three subsets**,
 $iA + iB + iC$

where i is an integer from 1 to 7

- The total number of voicechannels in a cell is about 45
- The minimum separation between three subsets is 7 channels $(21/3)$

Grouping into Subsets

- If six subsets are equipped in an omnnicell site,
- Minimum separation between two adjacent channels can be only three ($21/6 > 3$) physical channel bandwidths
- For Example

$$1A + 1B + 1C + 4A + 4B + 4C$$

or $1A + 1B + 1C + 5A + 5B + 5C$

Techniques for increasing frequency spectrum

- Increasing the number of radio channels using narrow banding, spread spectrum, or time division
- Improving spatial frequency-spectrum reuse
- Frequency management and channel assignment
- Reducing the load of invalid calls
 - Voice storage service for No-Answer calls
 - Call forwarding
 - Call waiting for Busy-Call situations
 - Queuing

Set-up Channels

- Set-up channels, also called ***control channels***,
- Channels designated to **set up** calls
- A system can be operated without set-up channels
- Set-up channels can be classified by usage into two types
 - *access channels*
 - *paging channels*

Access channels - Operational functions

- *Power of a forward set-up channel [or forward control channel (FOCC)]*
- *The set-up channel received level (Threshold)-RECC*
- *Change power at the mobile unit(Messages)*
 - *Mobile station control message*
 - *System parameter overhead message*
 - *Control-filler message*
- *Direct call - retry*

Mobile station control message

- DCC - Digital Color Code
- A Digital Signal transmitted by an FOCC to detect capture of an interfering mobile station
 - Mobile station uses DCC to identify the land station
 - MIN
 - VMAX
 - SCC

SCC – SAT Colour Code

DCC (from FOCC)	7 bit coded DCC on RECC	SCC	
00	0000000	SCC ≠ 11	5970 Hz
01	0011111		6000 Hz
10	1100011		6030 Hz
11	1111100	11	Not a channel designation

System parameter overhead message

- SID - A digital identification uniquely associated with a cellular system(15-bit)
- CMAX
- CPA - Combined paging/access
 - CPA = 1 Paging & access channel are the same
 - CPA = 0 Paging & access channel are not the same

Control-filler message

- CMAC - a control mobile attenuation code
- the mobile station has to adjust its transmitter power level before accessing a system on a RECC

Paging Channels

- The assigned forward set-up channel (FOCC) of each cell site is used to page the mobile unit with the same mobile station control message

Selecting a voice channel

- For mobile-originating calls
- For paging calls

Channel Assignment to the Cell Sites- *Fixed Channel Assignment*

- Set-up channels & Voice channels
- long-term basis

Fixed Channel Assignment

- Setup-channels
 - 21 channels
 - $N = 4, 7, 12$ cell reuse patterns
 - Omni-directional antennas
 - One channel per cell
 - Unused set-up channels
 - Avoid interference between block A and B

Fixed Channel Assignment

- Voice Channels
 - 21 subsets
 - Min. co-channel & Adjacent channel interference
- 3 SAT Tones

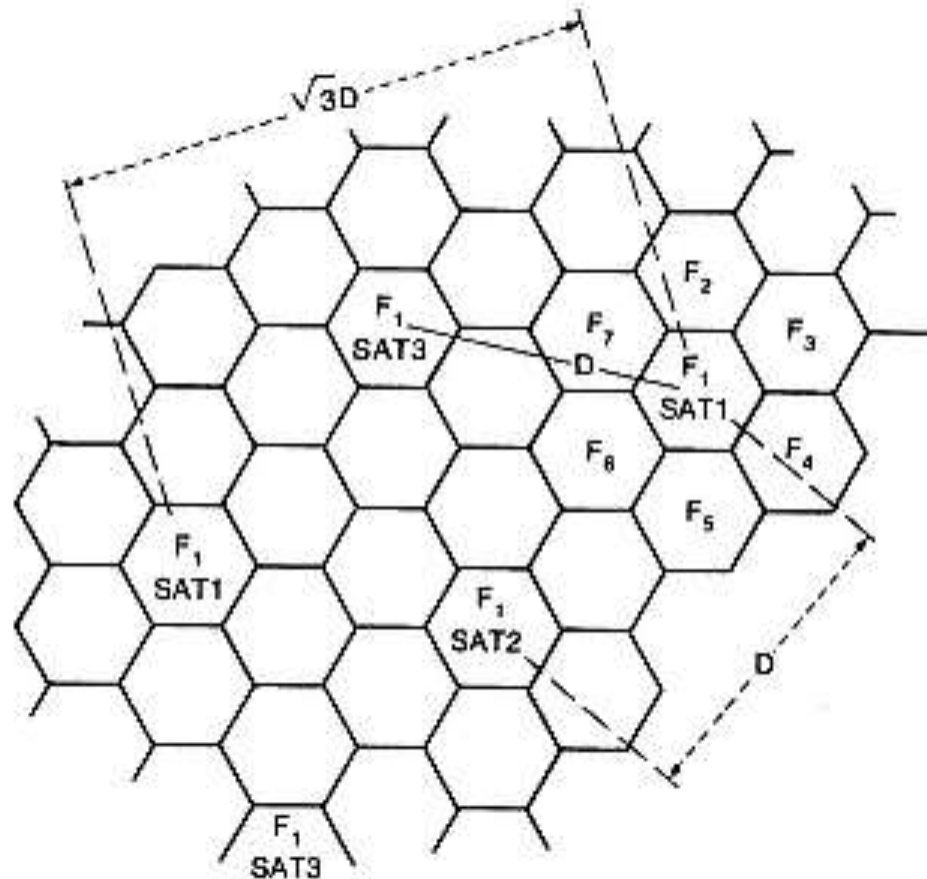

Channel Assignment to Travelling Mobile Units

- Underlay-overlay
- Frequency Assignment
- Tilted Antenna

Channel Assignment to Travelling Mobile Units

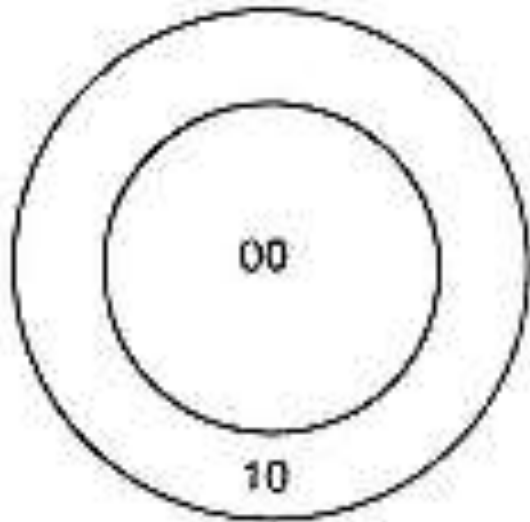

(a)

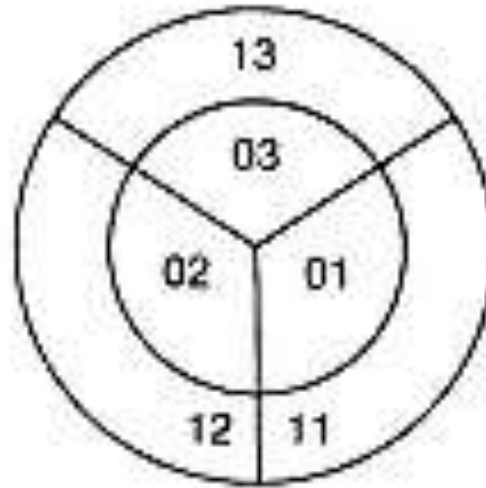

(b)

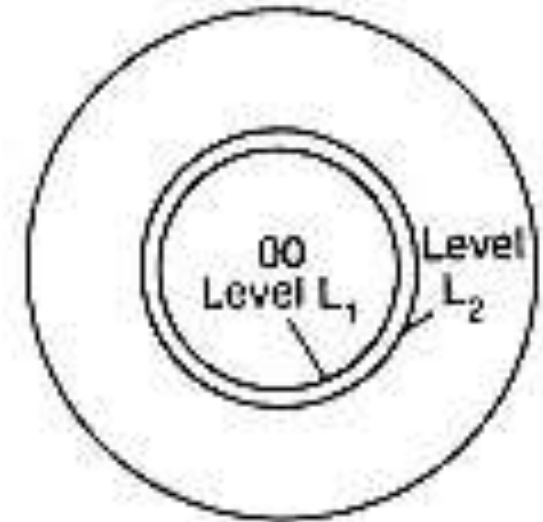

(c)

Underlaid-overlaid cell arrangements

(a) Underlay-overlay in omnnicell

(b) underlay-overlay in sectorized cells

(c) two-level handoff scheme

Underlay-overlay arrangement

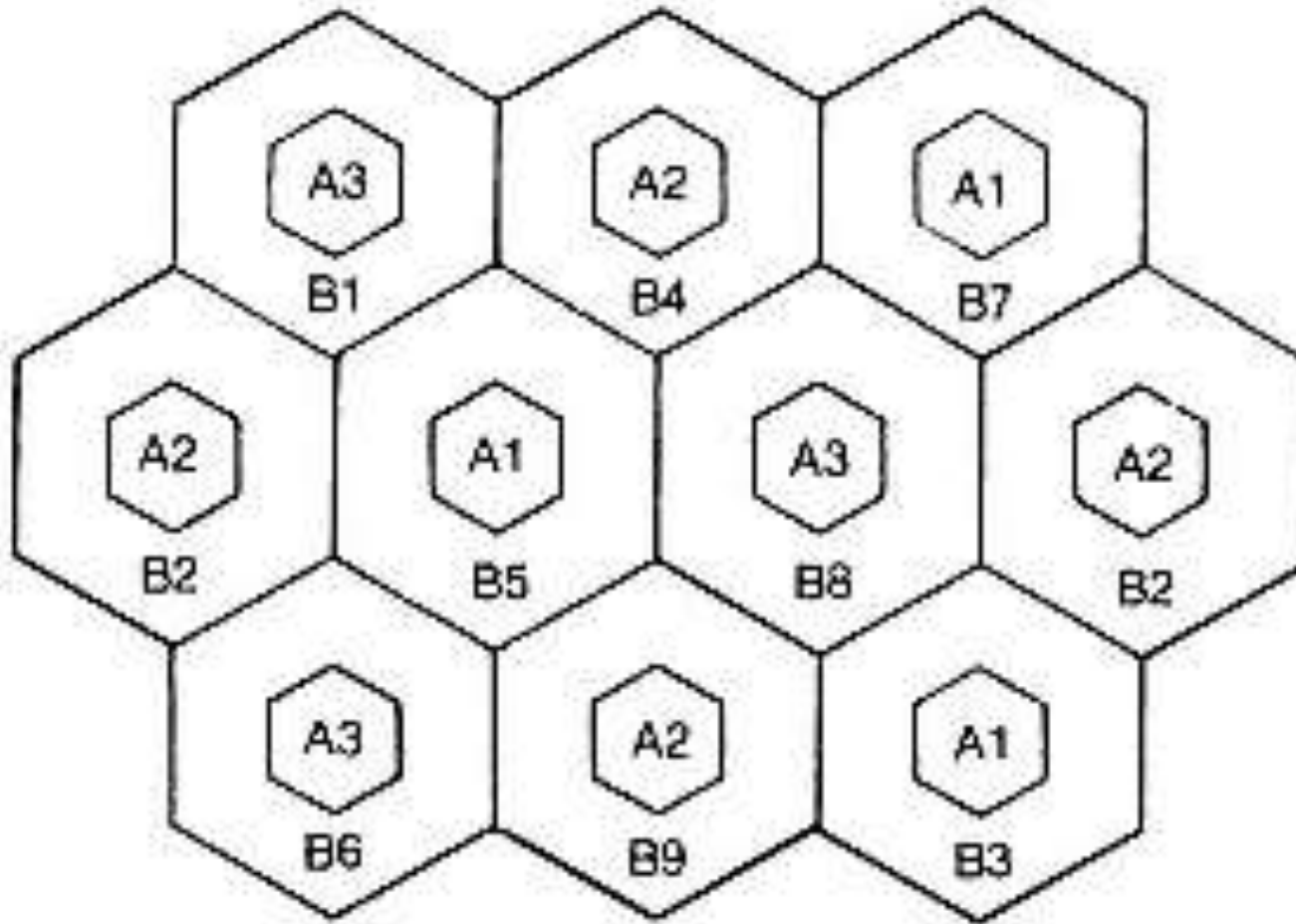

Fixed Channel Assignment

- *Adjacent-Channel Assignment*
- *Channel Sharing and Borrowing*
- *Sectorization*

Adjacent-Channel Assignment

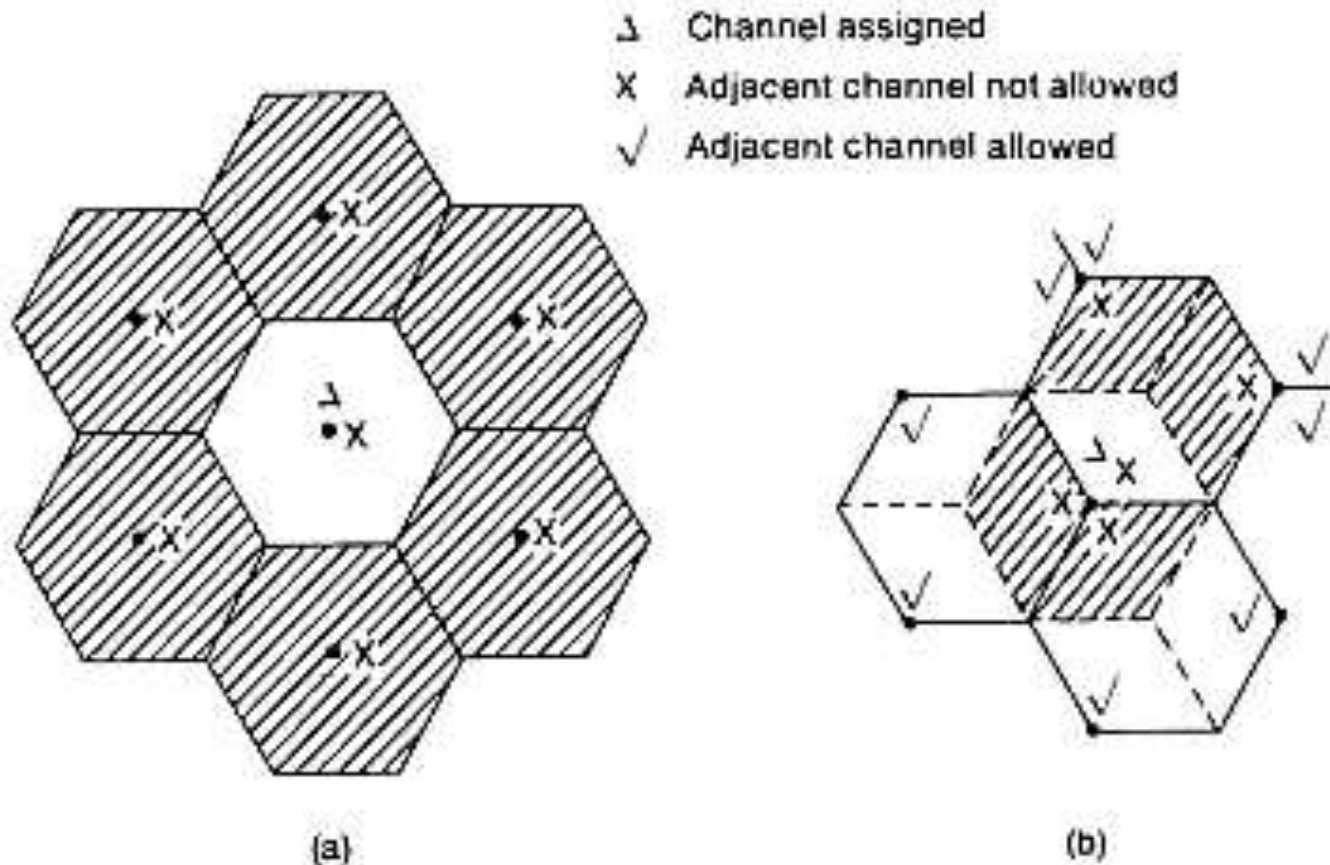

Adjacent channel assignment.
(a) Omnidirectional-antenna cells
(b) directional-antenna cells

Channel Sharing and Borrowing

- Channel Sharing Algorithm

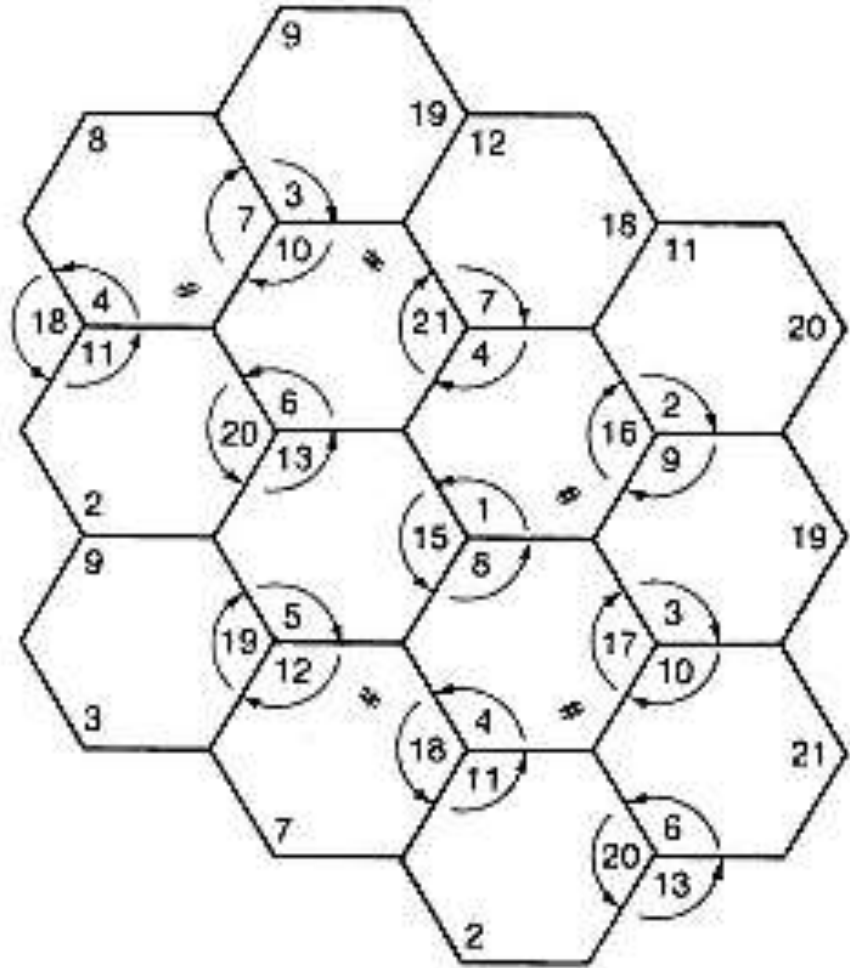

possible interference area

Sectorization

- The 120° sector cell for both transmitting and receiving
- The 60° sector cell for both transmitting and receiving
- 120° or 60° sector cell for receiving sectorization only, and transmitting antenna is omni-directional

Non-Fixed Channel Assignment algorithms

- Dynamic Channel Assignment
- Hybrid channel Assignment
- Borrowing channel Assignment
- Forcible-borrowing channel Assignment

Simulation process and results

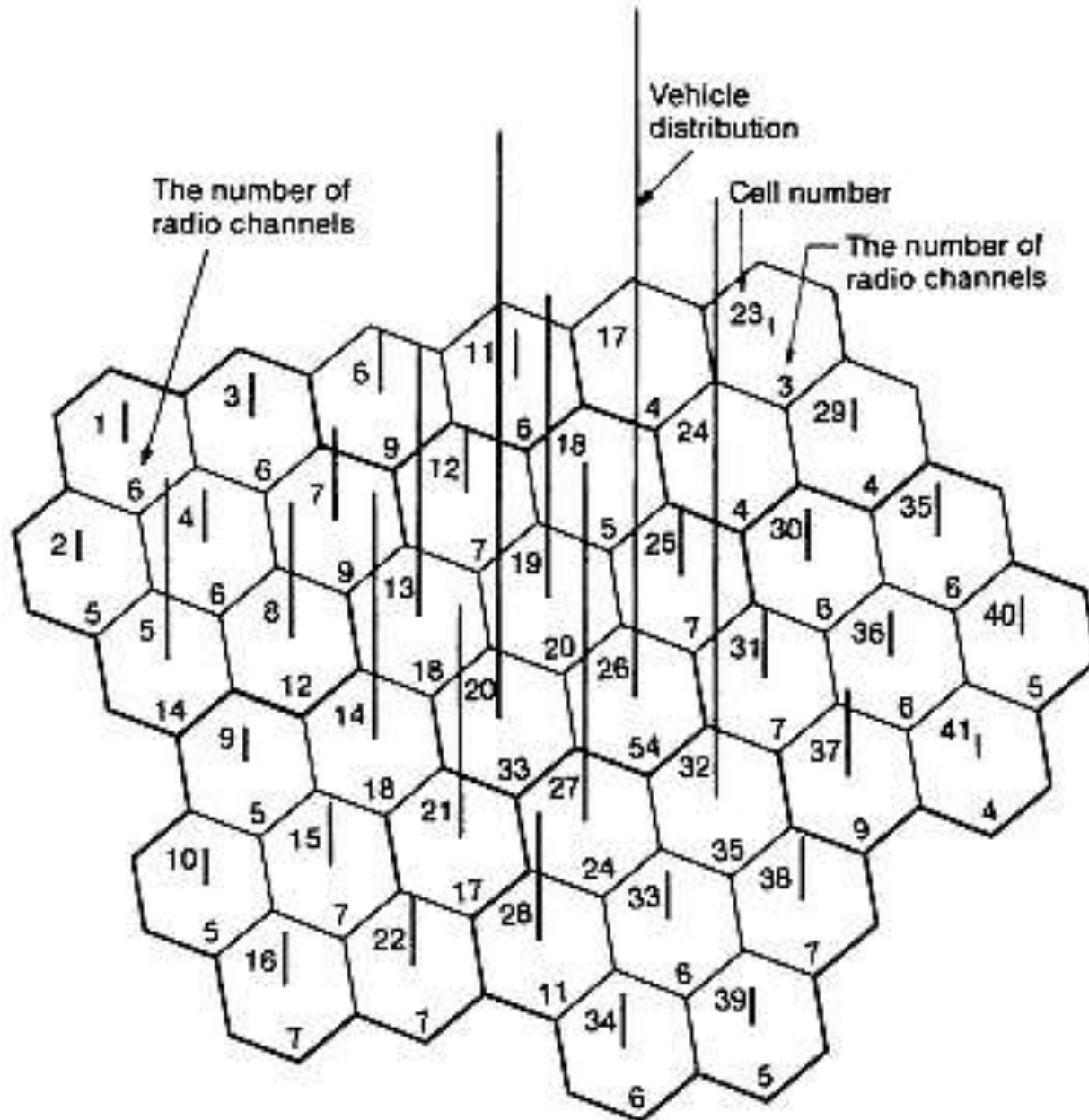

Cellular system.
Vehicle and radio-channel distribution in the busy rush hour

Simulation process and results

- Average Blocking
- Handoff Blocking

UNIT-V

HANDOFFS AND DROPPED CALLS

Sub topics

- Why Handoff
- Types of Hand off and their characteristics
- Dropped call rates and their evaluation

Why Handoffs?

- Handoff – voice channel
- Paging channels – Common Control channels
- value of implementing handoffs
- size of the cell
- people talk longer

Handoff

- Mobiles may move out of coverage area of a cell and into coverage area of a different cell during a call.
- MSC must identify new BS to handle call
 - MSC must seamlessly transfer control of call to new BS
 - MSC must assign call new forward and reverse channels within the channels of new BS
- Some important performance metrics in handoff:
 - Seamless – user should not know handoff occurring
 - Minimum unnecessary Handoff due to short time fading
 - Low probability of blocking new calls in the new cell
 - Handoff to a good SNR channel so that an admitted call is not dropped

What is a Handoff?

- Handoff refers to a process of transferring an ongoing call or data session from one channel connected to the core network to another.
- Process of transferring a MS from one base station to another.
- Also called as 'Handover'.

Reasons for a Handoff to be conducted

- To avoid call termination: call drops
- When the capacity for connecting new calls of a given cell is used up.
- Interference in the channels.
- When the user behaviors change.
 - Speed and mobility.

Different cell structures

- Macro cells

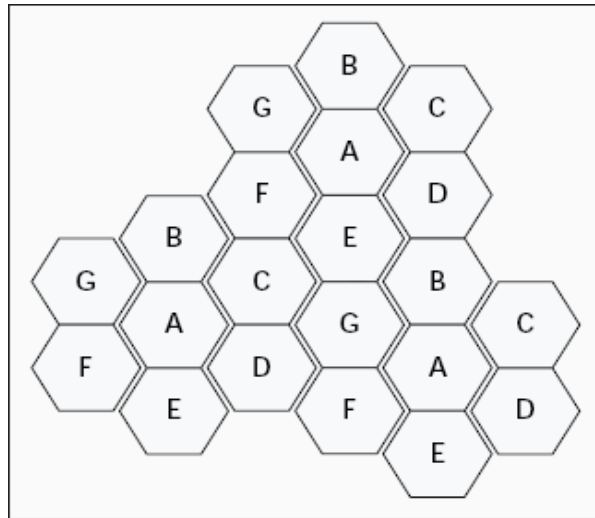

Seven cell clusters in a macro cellular system.

Types of Handoffs

- Hard handoff: “*break before make*” connection
 - Intra and inter-cell handoffs

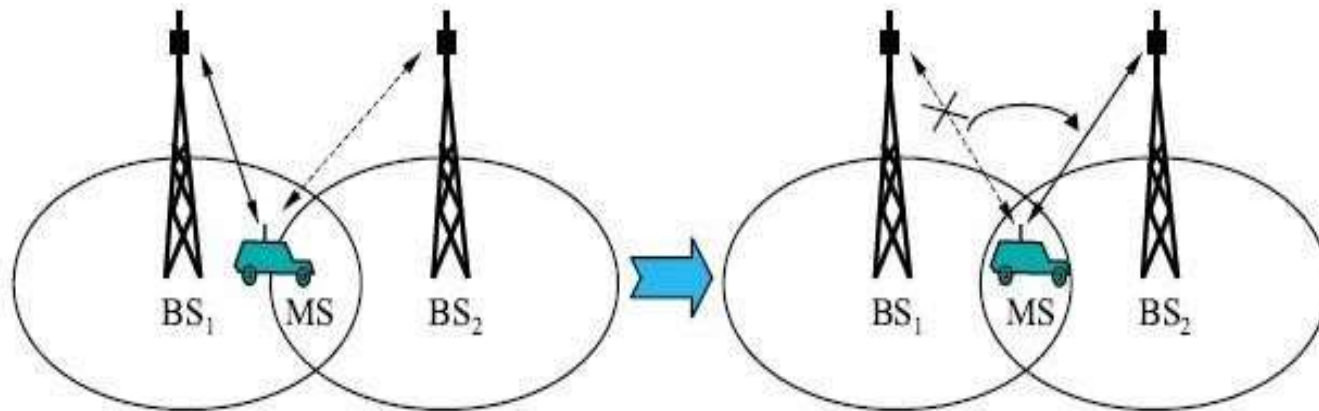

Hard Handoff between the MS and BSs

Handoff Main Steps

1. **Initiation**
2. **Resource reservation**
3. **Execution**
4. **Completion**

Important handoff parameter:

SNR_{old} to initiate handoff based on minimum acceptable quality

SNR_{new} of the target channel ($SNR_{new} > SNR_{old}$)

$D = SNR_{new} - SNR_{old}$ dB

- If D too small, unnecessary handoffs occur
- If D too large, may be insufficient time to complete handoff before SNR_{old} becomes too weak and signal is lost

Occurrence of handoff

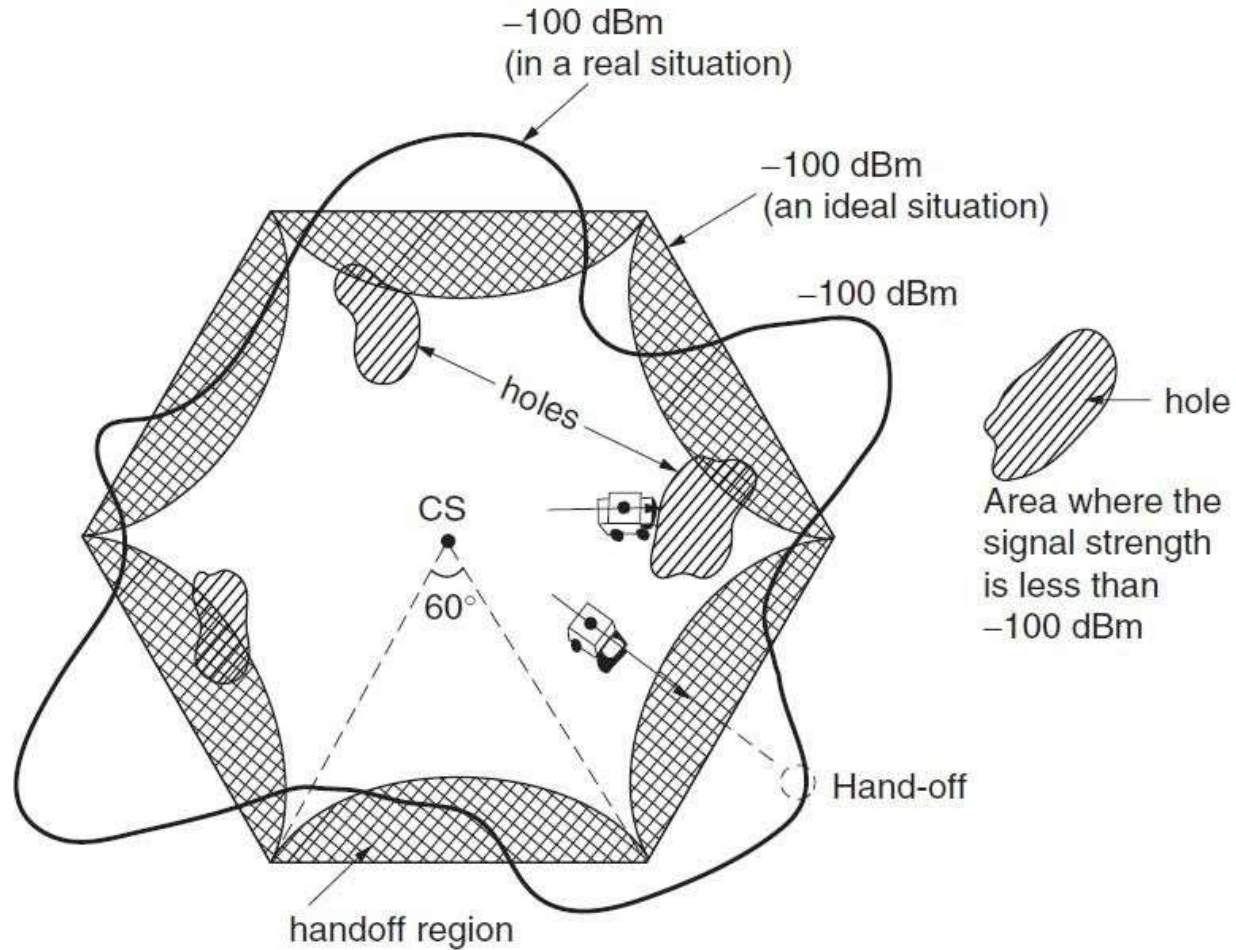

Types of Handoff

A. Natures of handoff

- 1. Hard handoff - Break Before Make**
- 2. Soft handoff - Make Before Break**
- 3. Softer handoff**

B. Purposes of handoff

- 1. Intracell handoff**
- 2. Intercellhandoff**
- 3. Inter BSC/MSC handoff**

4. Intersystem handoff:

5. Inter-carrier handoffs:

6. Inter-mode handoff:

C. Algorithms of handoff

1. MCHO (Mobile Control Handoff)

2. NCHO (Network Control Handoff)

3. NCHO/MAHO (Network Control Handoff/Mobile Assists Handoff)

INITIATION OF HANDOFF

- Signal strength - reverse voice channel
- Threshold level - minimum required voice quality
- Cell site – MTSO
- Unnecessary Handoff
- Failure Handoff

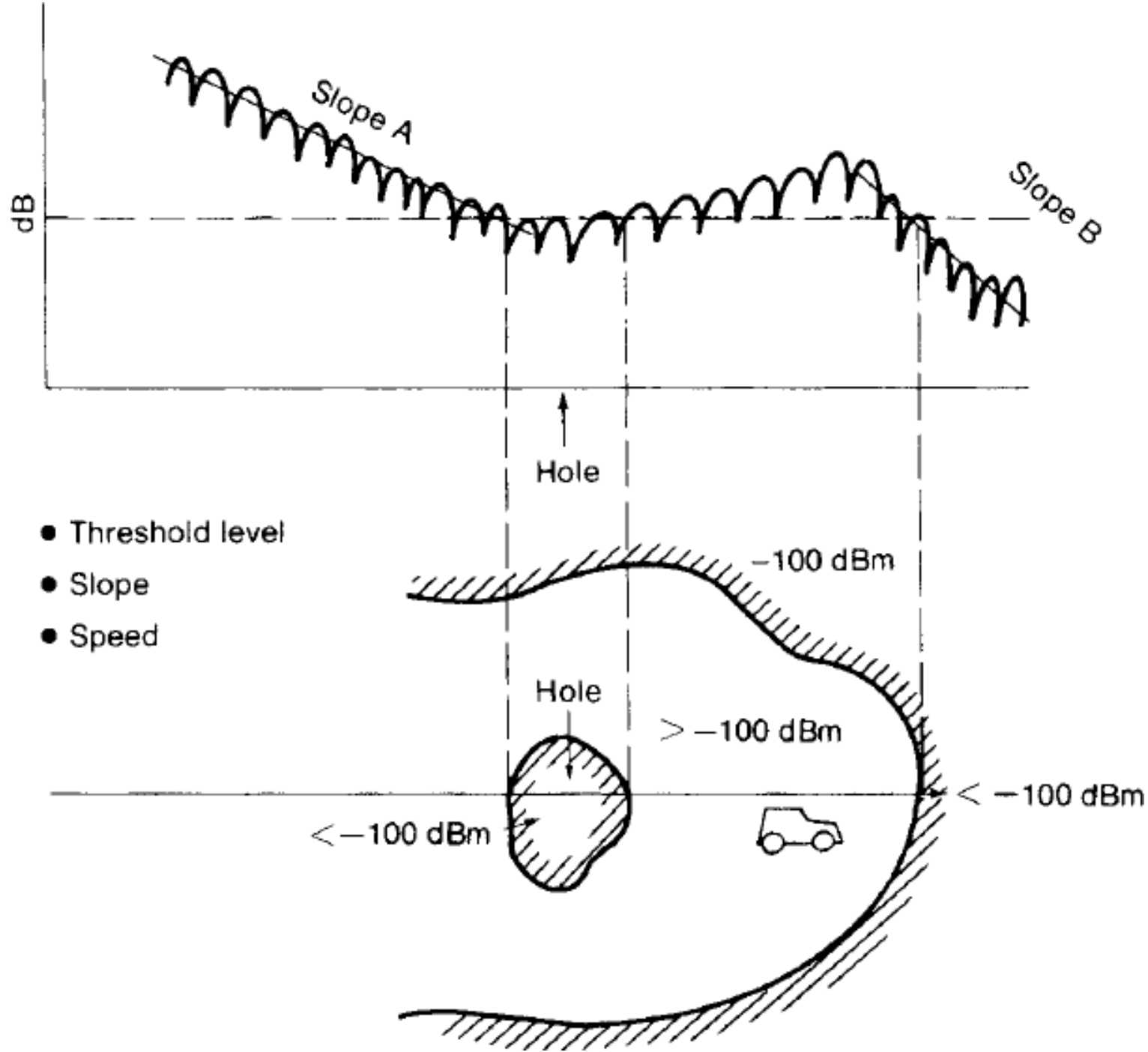

$$V = \left\{ \begin{array}{l} \frac{n\lambda}{\sqrt{2\pi}(0.27)} \text{ ft/s} \\ n\lambda \text{ mi/h} \end{array} \right\} \text{ at } -10\text{-dB level}$$

The velocity of vehicle V and the pathloss slope γ , can be used to determine the value of Δ dynamically

DELAYING A HANDOFF

- A Two-Level Handoff Algorithm
- Advantage of Delayed Handoffs
 - Switching processor
 - Interference

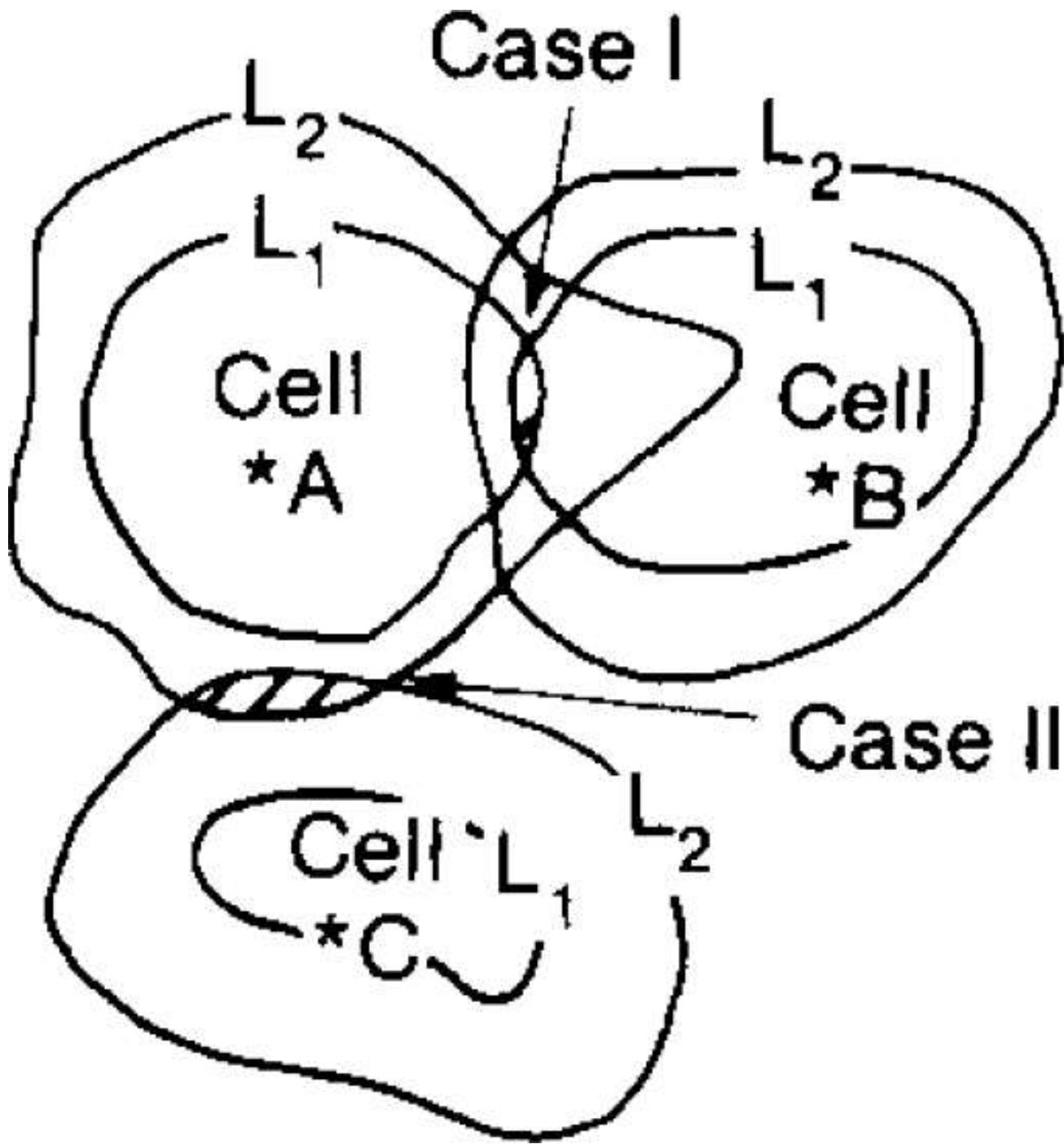

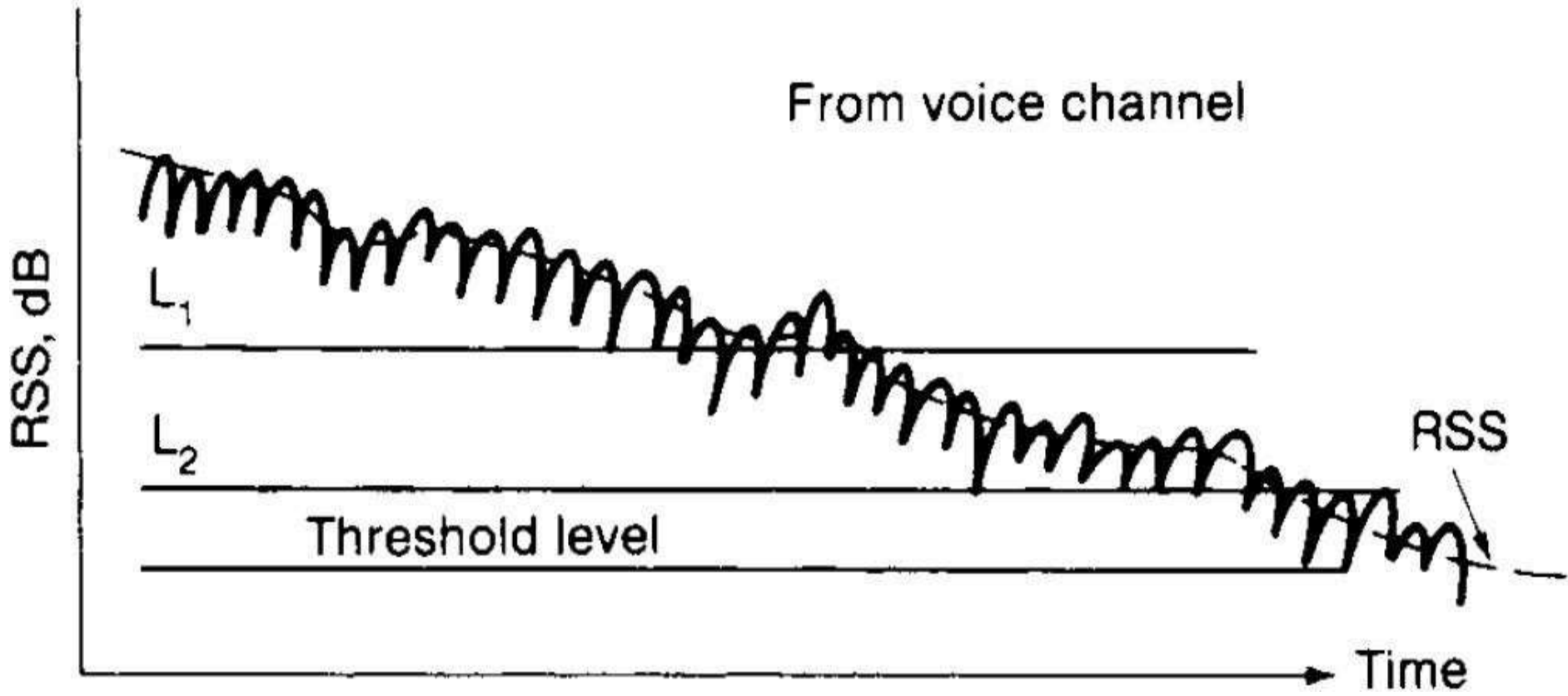

Advantages of handoff

1. If the neighboring cells are busy delayed handoff helps to continue the call in progress smoothly till the new cell gets free.
2. In two-handoff-level algorithm only after the second handoff the call will be dropped. Thus probability of call blocking is very less.
3. This algorithm also makes handoff to take place at correct location.
4. The algorithm avoids interference in the system.

POWER-DIFFERENCE HANDOFFS

- power difference (Δ)

$\Delta =$ the mobile signal measured at the candidate handoff site
– the mobile signal measured at the home site

For example, the following cases can occur.

$\Delta > 3 \text{ dB}$	request a handoff
$1 \text{ dB} < \Delta < 3 \text{ dB}$	prepare a handoff
$-3 \text{ dB} < \Delta < 0 \text{ dB}$	monitoring the signal strength
$\Delta < -3 \text{ dB}$	no handoff

FORCED HANDOFFS

*A **forced handoff** is defined as a handoff that would normally occur but is prevented from happening, or a handoff that should not occur but is forced to happen.*

In forced handoff let us focus on few topics such as,

➤ Controlling a Handoff

- By cell site – threshold level - variation
- By MSC

➤ Creating a Handoff

- MSC ordering Cell site – threshold level increase

Mobile Assisted Handoff (MAHO)

- Every mobile measures received power from surrounding base stations and continually reports levels to the serving base station
- Handoff is initiated when Rx power of other than serving BTS is higher by a certain level and time
- Handoff requires continuous RSSI measurement of all channels

Intersystem Handoff

- In intersystem handoff, the new and old BSs are connected to two **different MSCs**.
- We trace the intersystem handoff procedure of IS-41, where network-controlled handoff (**NCHO**) is assumed.
- In this figure, a communicating mobile user moves out of the BS served by MSC A and enters the area covered by MSC B.

Intersystem Handoff

- Intersystem handoff requires the following steps:
- Step 1. MSC A requests MSC B to perform handoff measurements on the call in progress. MSC B then selects a candidate BS2, BS2, and interrogates it for signal quality parameters on the call in progress. MSC B returns the signal quality parameter values, along with other relevant information, to MSC A.

Intersystem Handoff

- Step 2. MSC A checks if the MS has made too many handoffs recently (this is to avoid, for example, numerous handoffs between BS1 and BS2 a where the MS is moving within the overlapped area) or if intersystem trunks are not available. If so, MSC A exits the procedure. Otherwise, MSC A asks MSC B to set up a voice channel. Assuming that a voice channel is available in BS2, MSC B instructs MSC A to start the radio link transfer.

Intersystem Handoff

- Step 3. MSC A sends the MS a **handoff order**. The MS synchronizes to BS2. After the MS is connected to BS2, MSC B informs MSC A that the handoff is successful. MSC A then connects the call path (trunk) to MSC B and completes the handoff procedure.

QUEUING OF HANDOFFS

- Queuing of handoffs is more effective than two-threshold-level handoffs
- $1/\mu$ - average calling time in seconds, including **new calls** and **handoff calls** in each cell
- λ_1 - arrival rate (λ_1 calls per second) for originating calls
- λ_2 - arrival rate (λ_2 handoff calls per second) for handoff calls
- M_1 - size of queue for originating calls
- M_2 - size of queue for handoff calls
- N - number of voice channels
- $a = (\lambda_1 + \lambda_2)/\mu$
- $b_1 = \lambda_1/\mu$
- $b_2 = \lambda_2/\mu$

Case – 1

- ***No queuing on either the originating calls or the handoff calls***
- The blocking for either an originating call or a handoff call is

$$B_o = \frac{a^N}{N!} P(0) \quad (11.5-1)$$

where

$$P(0) = \left(\sum_{n=0}^N \frac{a^n}{n!} \right)^{-1} \quad (11.5-2)$$

Case-2

- ***Queuing the originating calls but not the handoff calls***
- The blocking probability for originating calls is

$$B_{oq} = \left(\frac{b_1}{N} \right)^{M_1} P_q(0) \quad (11.5-3)$$

where

$$P_q(0) = \left[N! \sum_{n=0}^{N-1} \frac{a^{n-N}}{n!} + \frac{1 - (b_1/N)^{M_1+1}}{1 - (b_1/N)} \right]^{-1}$$

Dropped Call Rates

- The dropped call is defined as an established call which leaves the system before it is normally terminated
- The Dropped Call Rate (DCR) parameter represents what percentage of all established calls is dropped during a specified time period
- The DCR and voice quality are inversely proportional and high DCR may indicate coverage, handoff, or channels accessibility problems

The perception of dropped call rate by the subscribers can be higher due to:

1. The subscriber unit not functioning properly (needs repair).
2. The user operating the portable unit in a vehicle (misused).
3. The user not knowing how to get the best reception from a portable unit (needs education).